

INFINITY[®]

Total Ankle System

SURGICAL TECHNIQUE



INFINITY®
Total Ankle System

SURGICAL TECHNIQUE

SURGEON DESIGN TEAM

The INFINITY® Total Ankle System was developed in conjunction with:

Robert B. Anderson, MD
OrthoCarolina
Charlotte, NC

Gregory C. Berlet, MD
Orthopedic Foot and Ankle Center
Columbus, OH

W. Hodges Davis, MD
OrthoCarolina
Charlotte, NC

Steven L. Haddad, MD
Illinois Bone and Joint Institute
Chicago, IL

Thomas H. Lee, MD
Orthopedic Foot and Ankle Center
Columbus, OH

Murray J. Penner, MD FRCS
Providence Health Care
Vancouver, BC

Contents

Chapter 1	4	Product Information
	5	Intended Use
	5	Indications
	5	Contraindications
	6	Preoperative Planning
Chapter 2	8	Surgical Technique
	8	Surgical Approach
	8	Set Axial Rotation
	9	Attach Alignment Frame
	11	Coronal Plane (Varus/Valgus) Alignment
	16	Set Sagittal Plane (Flexion/Extension) Alignment
	19	Install Sizing and Resection Guide Adjustment Block
	20	Coronal Plane Sizing and Positioning
	23	Sagittal Plane Sizing and Resection Height
	27	Drill Tibial Corners
	28	Bone Resection
	30	Remove Tibial Bone Resection
	31	Tibial Tray Trialing and AP Sizing
	34	Tibial Peg Broaching
	35	Talar Component Sizing and Positioning
	37	Talar Chamfer Resections
	41	Polyethylene Thickness
	42	Talar Peg Drilling
	43	Tibial Component Implantation
	46	Talar Component Implantation
	47	Polyethylene Bearing Installation
	52	Explant Information
	52	Postoperative Management
Appendix A	53	INBONE® Talar Dome Technique
Appendix B	62	Talar Re-Cut Option
Appendix C	63	INFINITY® Instrumentation
Appendix D	72	Implant Specifications
Appendix E	73	Ordering Information

Proper surgical procedures and techniques are the responsibility of the medical professional. The following guidelines are furnished for information purposes only. Each surgeon must evaluate the appropriateness of the procedures based on his or her personal medical training and experience. Prior to use of the system, the surgeon should refer to the product package inserts (145283) for complete warnings, precautions, indications, contraindications and adverse effects. Package inserts are also available by contacting the manufacturer. Contact information can be found on the back of this surgical technique and the package insert is available on the website listed: wmt.com, under the link for Prescribing Information.

Please contact your local Wright representative for product availability.



General Product Information

Through the advancement of partial and total joint replacement, the surgeon has been provided with a means of restoring mobility, correcting deformity, and reducing pain for many patients. While the prostheses used are largely successful in attaining these goals, it must be recognized that they are manufactured from a variety of materials and that any joint replacement system, therefore, cannot be expected to withstand activity levels and loads as would normal healthy bone. In addition, the system, including the implant/bone interface, will not be as strong, reliable, or durable as a natural human joint.

Ankle joint replacement components consist of a talar dome, a tibial platform, and an UHMWPE component. Components are available in a variety of sizes and design configurations intended for both primary and revision applications.

Intended Use

The INFINITY® Total Ankle is intended to give a patient limited mobility by reducing pain, restoring alignment and replacing the flexion and extension movement in the ankle joint.

Indications

The INFINITY® Total Ankle is indicated for patients with ankle joints damaged by severe rheumatoid, post-traumatic, or degenerative arthritis.

The INFINITY® Total Ankle is additionally indicated for patients with a failed previous ankle surgery.

CAUTION: The ankle prosthesis is intended for cement use only.

Contraindications

Absolute contraindications include:

1. osteomyelitis;
2. excessive bone loss at the ankle joint site;
3. steroid use;
4. infection at the ankle site or infections at distant sites that could migrate to the ankle;
5. sepsis;
6. muscular atrophy;
7. dementia;
8. vascular deficiency in the ankle joint;
9. skeletally immature patients (patient is less than 21 years of age at the time of surgery);
10. cases where there is inadequate neuromuscular status (e.g., prior paralysis, fusion and/ or inadequate abductor strength), poor bone stock, poor skin coverage around the joint which would make the procedure unjustifiable;
11. neuropathic joints;
12. hepatitis or HIV infection;
13. excessive loads as caused by activity or patient weight;
14. female of childbearing age, for whom a negative pregnancy test is not obtained; and,
15. neurological or musculoskeletal disease that may adversely affect gait or weightbearing.

Conditions presenting increased risk of failure include:

1. uncooperative patient or patient with neurologic disorders, incapable of following instructions;
2. marked bone loss, severe osteoporosis, or revision procedures for which an adequate fit of the prosthesis cannot be achieved;
3. metabolic disorders that may impair bone formation;
4. osteomalacia; and,
5. poor prognosis for good wound healing (e.g., decubitus ulcer, end-stage diabetes, severe protein deficiency and/or malnutrition).

Prior to use of the system, the surgeon should refer to the product package insert for complete warnings, precautions, indications, contraindications and adverse effects. Package inserts are also available by contacting the manufacturer. Contact information can be found on the back of this surgical technique and the package insert is available on the website listed.

Preoperative Planning

Preoperative assessment of the appropriate size and position of the tibial and talar components will provide intraoperative guidance for component selection.

Radiographic overlays for the INFINITY® Total Ankle System are available in 0% and 10% magnification, and represent both the AP and Lateral profile of the prosthesis.

CAUTION: Preoperative templating is intended for estimation purposes only. Final component size and position should be determined intraoperatively through direct visualization under fluoroscopic assistance.

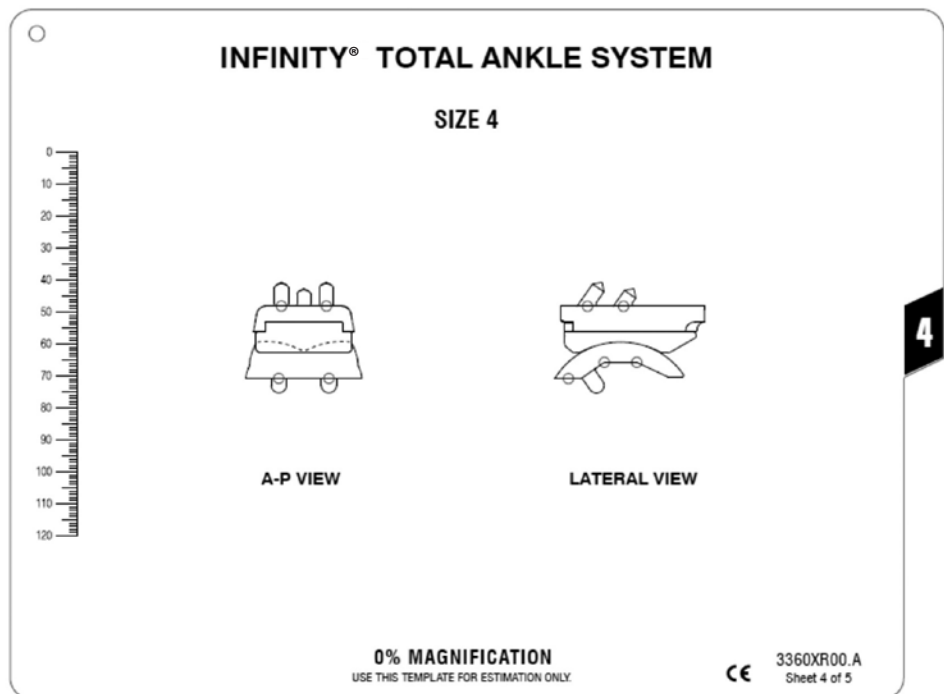

3360XR00 INFINITY® Total Ankle X-ray Template 0% Magnification

3360XR10 INFINITY® Total Ankle X-ray Template 10% Magnification

Surgical Technique

Surgical Approach

Make the anterior incision centered on the ankle, directly lateral to the palpable tibialis anterior tendon and medial to the extensor hallucis longus tendon. Define and avoid the deep peroneal nerve and anterior tibial artery. Once the nerve bundle is mobilized, the anterior ankle (distal tibia and talus) is exposed with the dorsal talonavicular joint representing the distal extent of the incision. This incision can be modified according to the specific needs of the patient.

Insert the Medial Gutter Fork (33600009 or 33600010) into medial gutter of the ankle joint, roughly perpendicular to the axis of the tibia. Ensure it is placed deep into the medial gutter, as this will establish the ultimate axial rotation of the prosthesis. | **FIGURE 1 and 2**



Medial Gutter Fork
Small: 33600009
Large: 33600010



| **FIGURE 1**

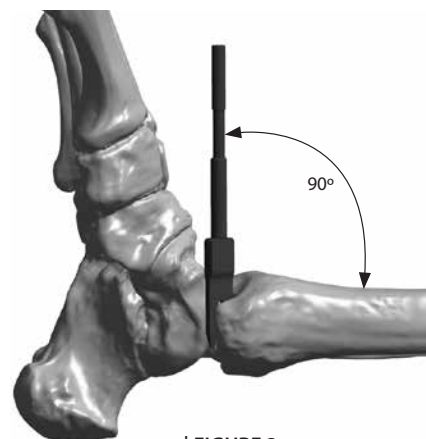

| **FIGURE 2**



Rotation Guide Pointer
33600011



Rotation Guide Slide
33600012

Set Axial Rotation

Assemble the Rotation Guide Pointer (33600011) and the Rotation Guide Slide (33600012) and install over the end of the Medial Gutter Fork. | **FIGURE 3** Slide the Rotation Guide Pointer medial/lateral to reach the approximate center of the tibia. Rotate the Rotation Guide Slide about the gutter fork until the Pointer is aligned approximately to the mechanical axis of the tibia.



| **FIGURE 3**

Install a 3.2mm Pin (33610001) through the hole in the Rotation Guide Pointer and through both cortices. | **FIGURE 4** Then remove the Pointer, Slider, and Gutter Fork. | **FIGURE 5**

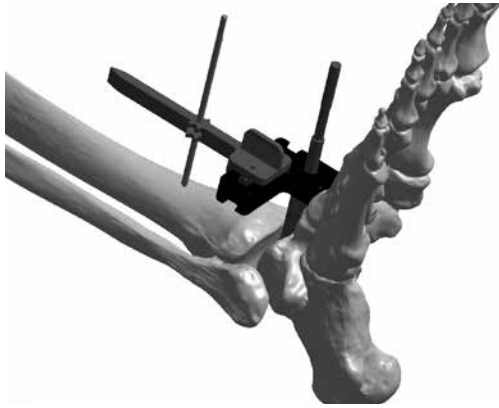

| **FIGURE 4**

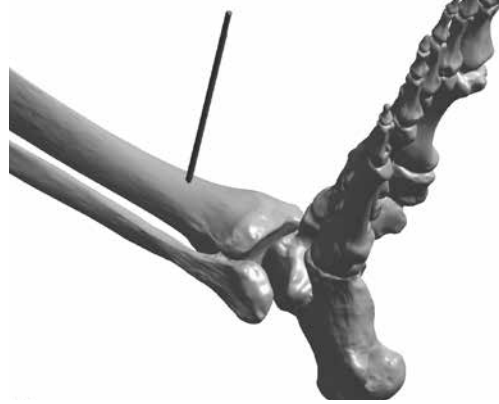

| **FIGURE 5**

Attach Alignment Frame

Assemble the Alignment Frame by sliding the end of the Proximal Alignment Frame Sub-Assembly (33600021) into the Distal Alignment Frame Sub-Assembly (33600020). Slide the Alignment Frame over the distal pin | **FIGURE 6** and align the proximal end to the proximal tibia. Install a 3.2mm Pin percutaneously through the proximal hole of the Alignment Frame into the tibial tuberosity. Turn the most proximal knob to loosely lock the frame to the pin. | **FIGURE 7**

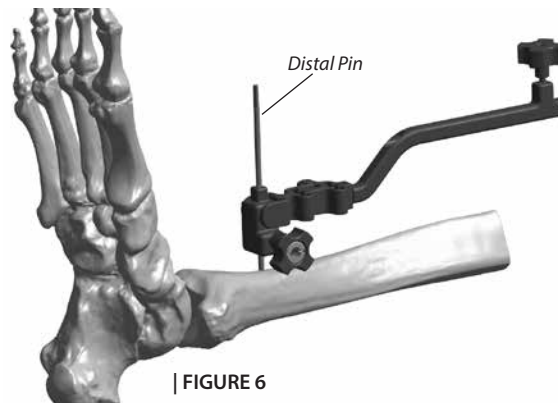

As an alternative to placing a pin in the proximal tibia, the Knee Bracket (33600022) and Rubber Strap (200430) can be used. For this method, first slide the Knee Bracket post into the proximal hole of the Alignment Frame. | **FIGURE 8** Then position the Knee Bracket over the proximal end of the tibia and secure in place using the Rubber Strap.

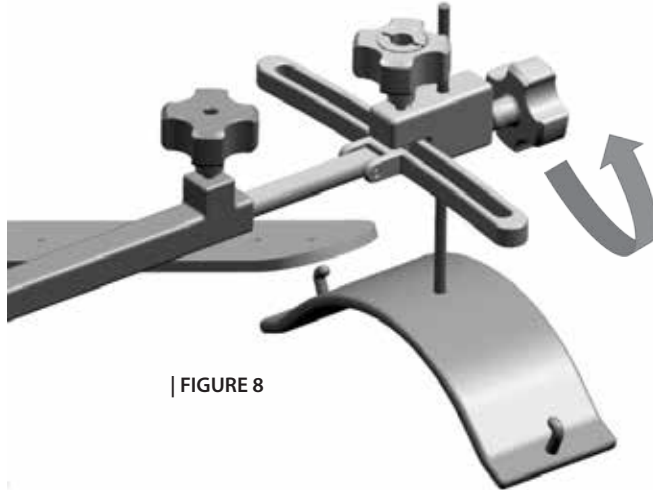

| **FIGURE 8**

In order to provisionally set the height of the Alignment Frame upon the distal pin, place two fingers between the distal portion of the frame and the distal tibial crest (approximately 20 to 25mm). Then lock the most distal knob. | **FIGURE 9**

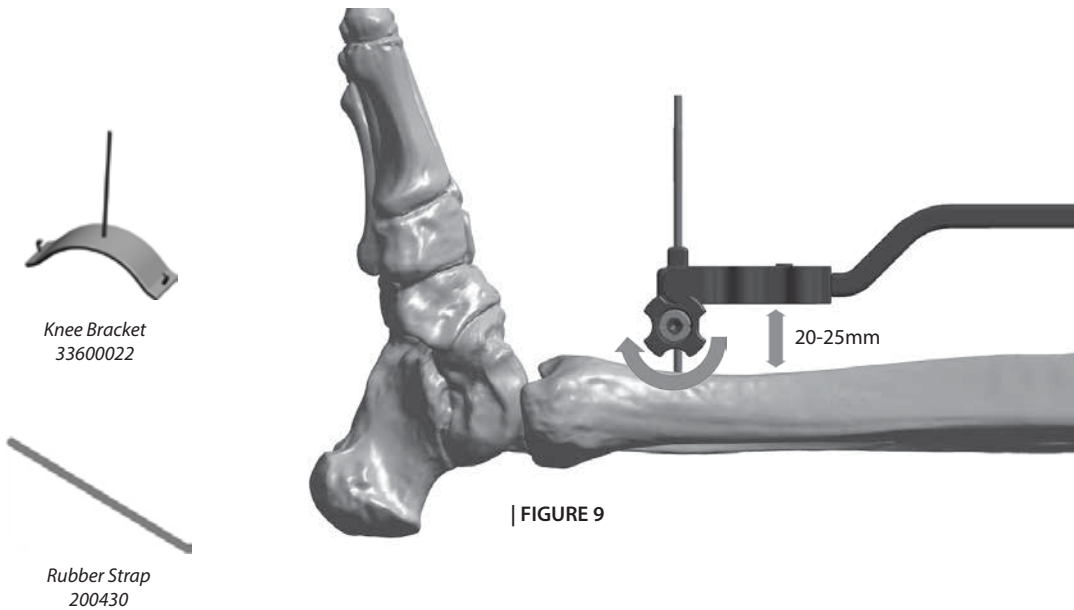

| **FIGURE 9**

Coronal Plane (Varus/Valgus) Alignment

Attach the Alignment Wing Guide (33600023) onto the Alignment Frame and secure with the Hex Driver (E5001005) and set screw. | FIGURES 10 and 11 Loosen the set screw to allow proximal/distal adjustment of the Alignment Wing.

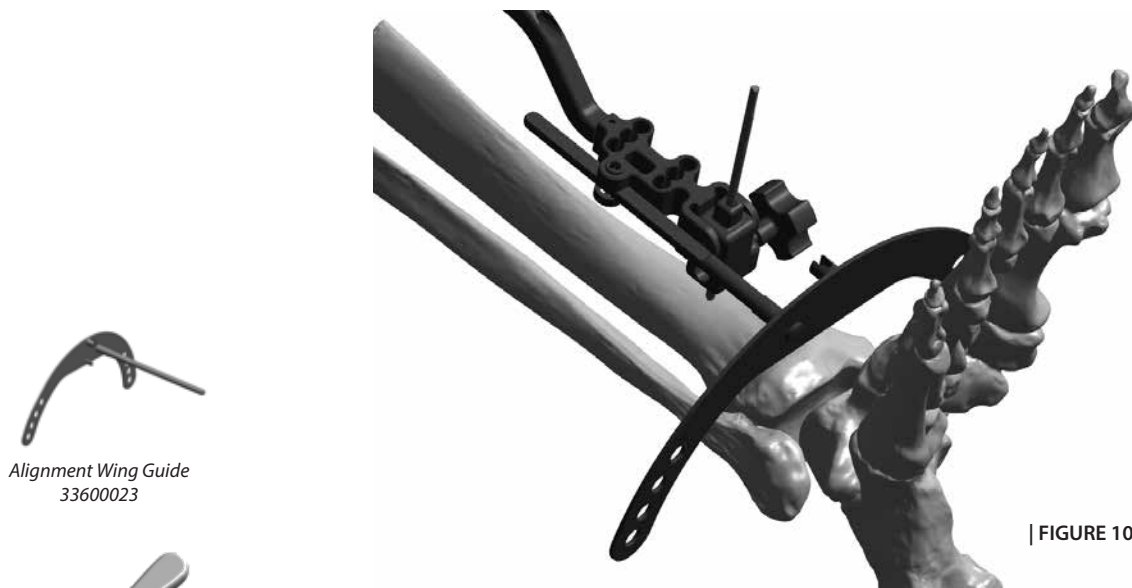

| FIGURE 10

CAUTION: It is important to ensure the arm of the alignment wing is assembled flush to the alignment frame | FIGURES 11 and 12

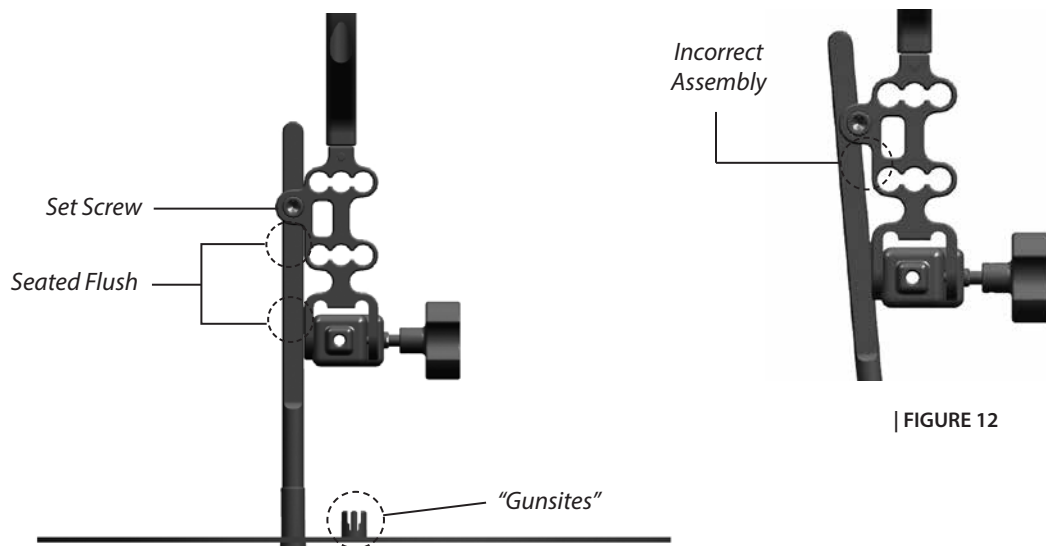

| FIGURE 11

| FIGURE 12

There are two separate parallax cues for establishing a true fluoroscopic view in the coronal plane.

1. A set of “gun sites” are located on the alignment wing. | **FIGURES 13 and 14** To get these lined up correctly, make very small “rainbow” or orbital adjustments with the c-arm. Alternatively the surgeon can internally/externally rotate the leg.

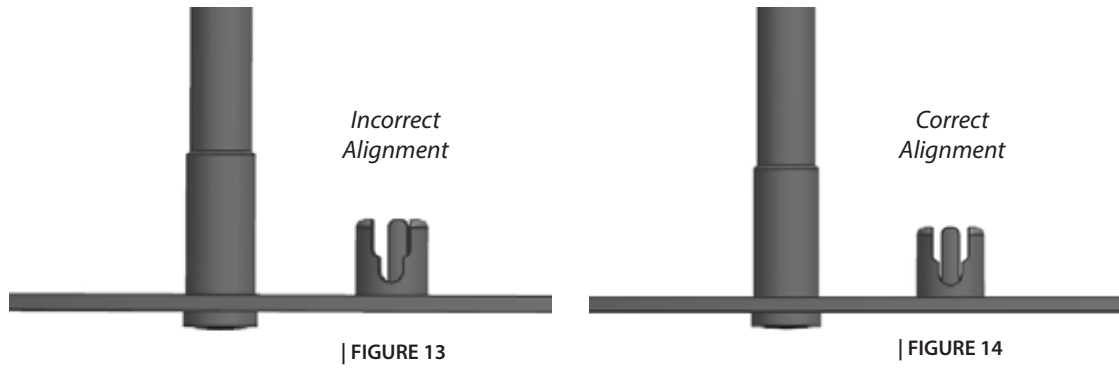

2. The width of the Alignment Wing should appear as a thin uniform line | **FIGURE 16** If it does not | **FIGURE 15** slightly “tilt” the c-arm to adjust. Alternatively the surgeon can raise/lower the foot.

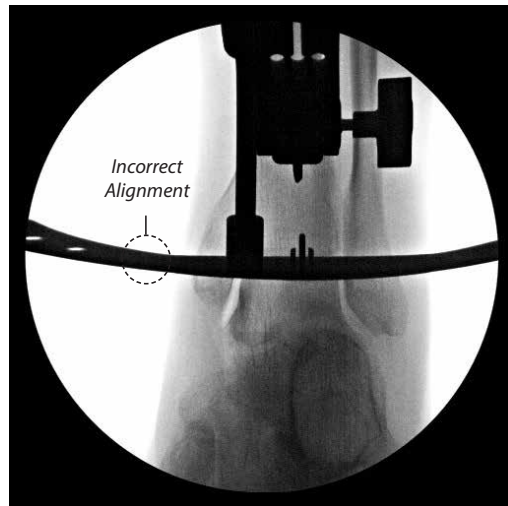

| FIGURE 15

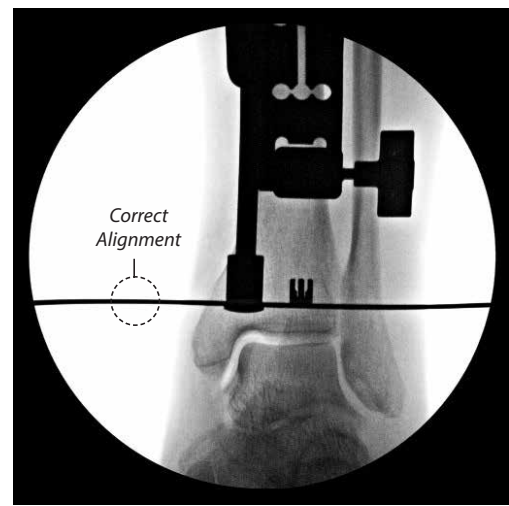

| FIGURE 16

The Alignment Frame can now be adjusted to establish coronal rotation (varus/valgus). Loosen the grey color-coded knob at the proximal end of the Alignment Frame to adjust coronal rotation. | **FIGURE 17** Tighten knob when adjustment is set.

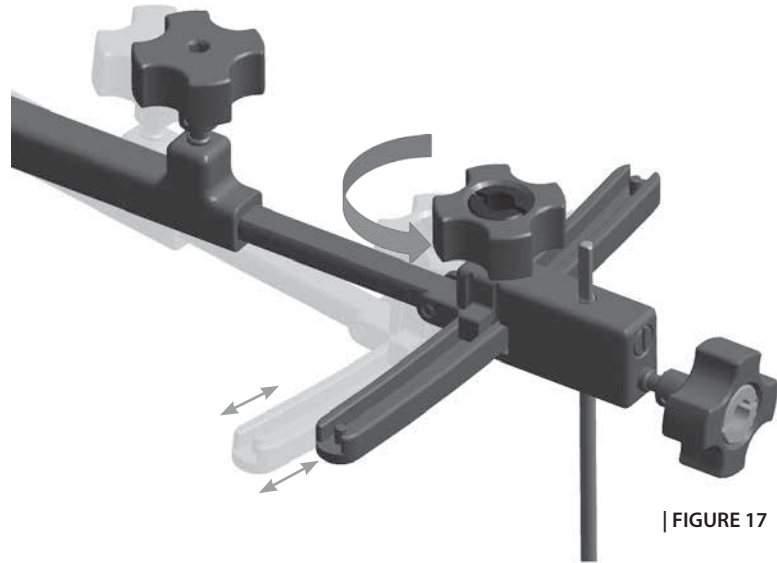

| **FIGURE 17**

Under A/P fluoroscopy use the position of the Alignment Wing to establish desired coronal alignment. | **FIGURE 18 and 19**

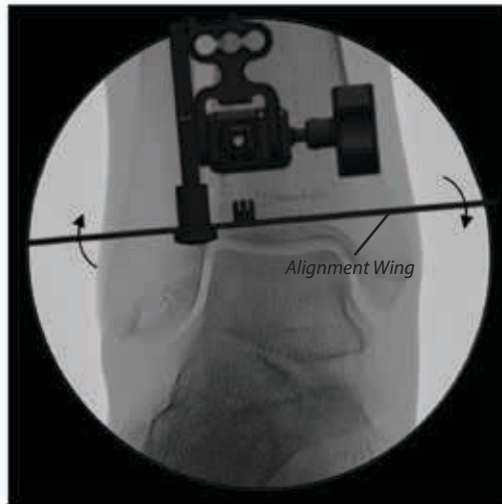

| **FIGURE 18**

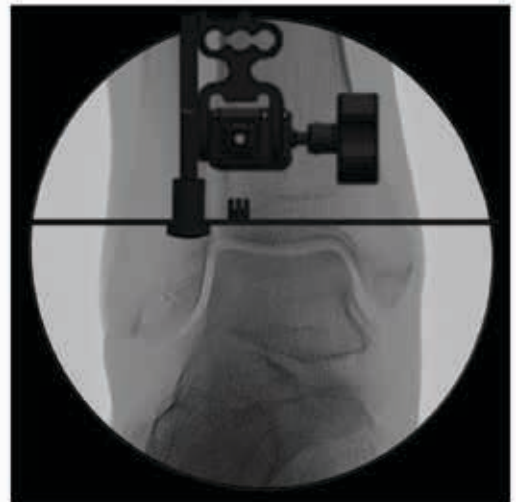

| **FIGURE 19**



Alternately, for a coronal fluoroscopic rotational reference, the surgeon can attach the Coronal Alignment Rod (36000027) to the Alignment Wing. Attach by sliding the base of the rod over the wing, with the rod pointing proximally. Thread down the rod to clamp down on the wing.

Typically, the distal tibial resection is set perpendicular to the mechanical axis of the tibia in the coronal plane (i.e. varus/valgus alignment). In many cases, the mechanical axis and the distal tibial anatomic axis are near parallel, and the tibial plafond is perpendicular to these axes. In these cases, the long axis of the external Alignment Frame may be aligned to the mechanical or anatomic axis by placing the Alignment Wing parallel to the distal tibial plafond. | **FIGURE 20**

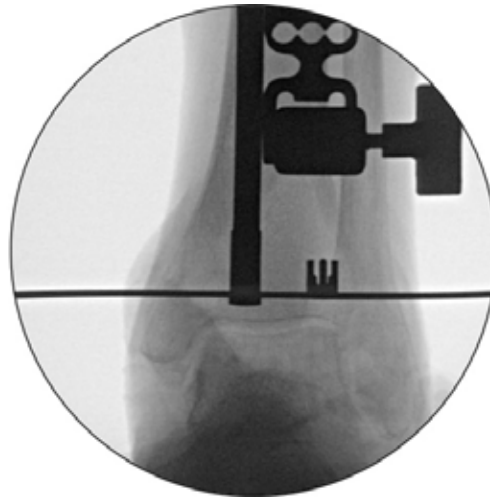

| **FIGURE 20**



— Tibia Mechanical Axis
 — Tibia Anatomic Axis

| **FIGURE 21**

In situations where the distal tibial anatomic axis is not parallel to the mechanical axis | **FIGURE 21**, or the tibial plafond is not perpendicular to the mechanical axis, coronal plane alignment is typically achieved by aligning the external alignment frame to the mechanical axis by visualizing the position of the frame relative to the full length of the tibia with the c-arm. | **FIGURE 22**



Distal Frame View

Middle Frame View

Proximal Frame View

| **FIGURE 22**

It is important to realize that parallax from the image intensifier may distort the perceived position of the alignment rod. The surgeon must be cognizant of this. As such, the surgeon must study the preoperative radiographs to determine the appropriate coronal plane alignment, determining the varus/valgus alignment of the Alignment Wing with reference to the tibial plafond based on these radiographs. Views of the entire tibia, or entire limb (hip/knee/ankle), may be necessary to determine this alignment. Using this information, the blade may NOT be parallel to the tibial plafond, and the surgeon may resect more bone medially or laterally with the joint depending on the deformity encountered.

Set Sagittal Plane (Flexion/Extension) Alignment

Assemble the Alignment Rod (33600024) into one of the four holes in either side of the Alignment Wing. | **FIGURE 23** Choose a hole that will allow visualization of both the Rod and the tibia in the sagittal plane.

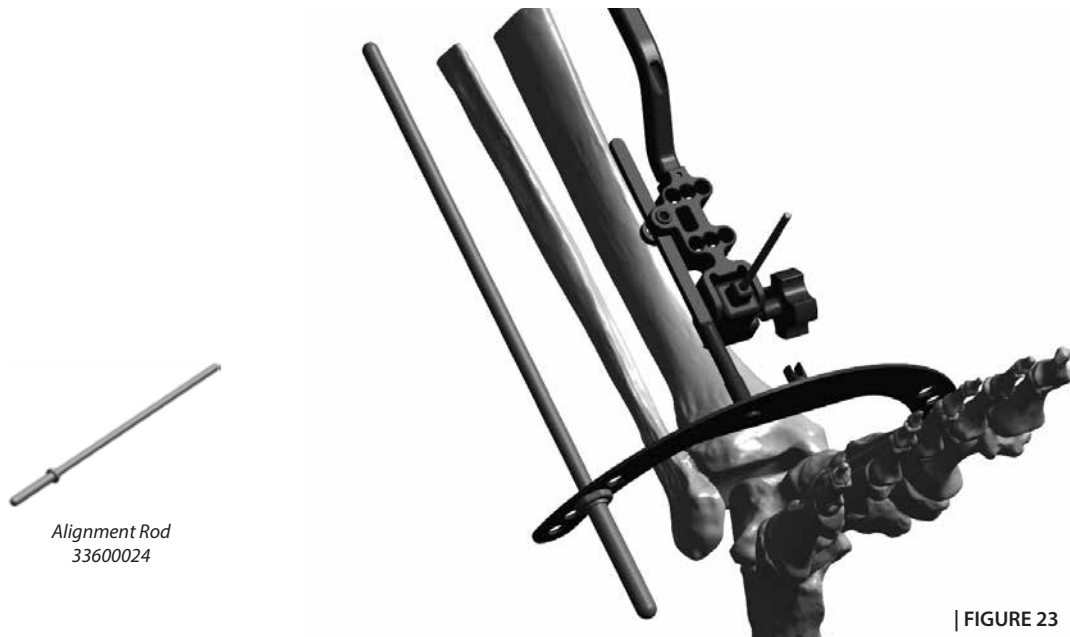

To establish a true lateral fluoroscopic view, adjust the c-arm until the Alignment Wing appears as one solid thin line. If there is appearance of a double line, | **FIGURE 24**, adjust the position of the leg or c-arm until the two lines become one. | **FIGURE 25**

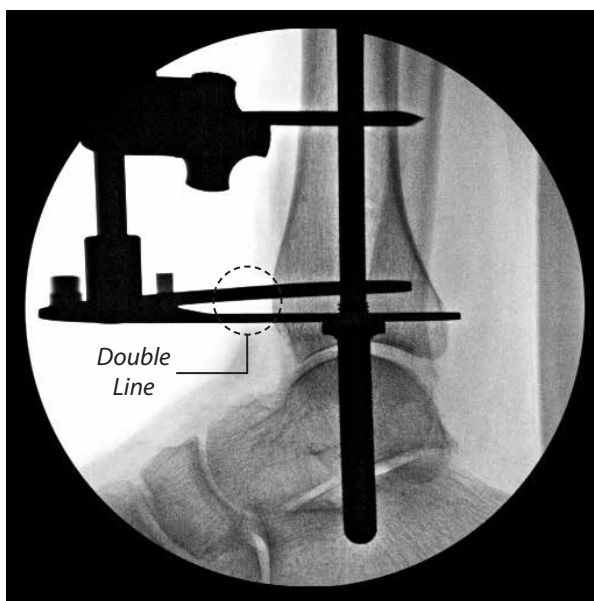

| **FIGURE 24**

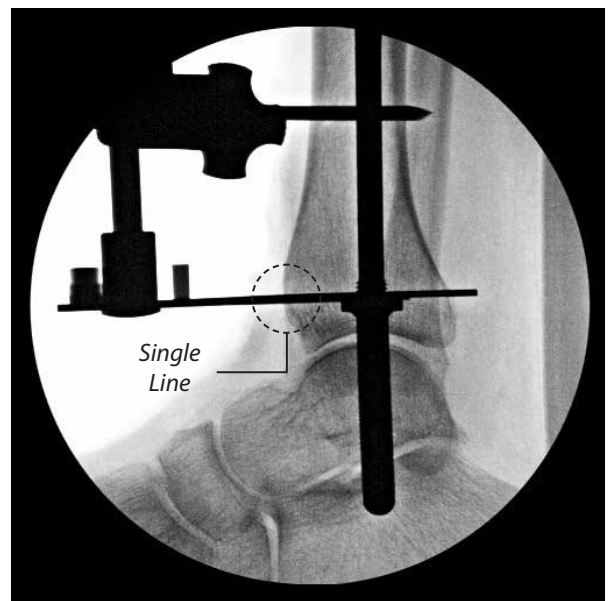

| **FIGURE 25**

To adjust the flexion angle of the prosthesis with respect to the distal tibia, loosen either of the two aqua color-coded knobs. Knobs are located on both the proximal and distal end of the frame. | FIGURES 26 and 27

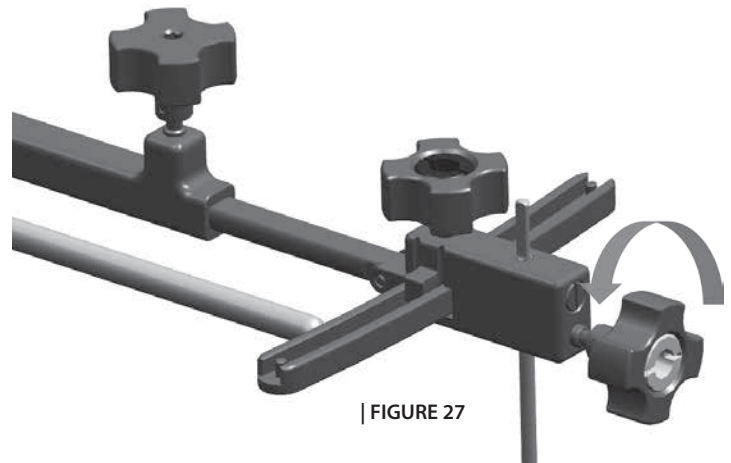
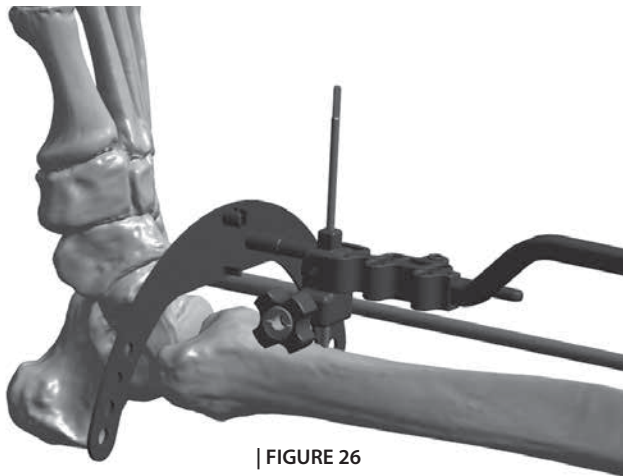

Under lateral fluoroscopy use the position of the Alignment Rod to establish desired sagittal rotation. Typically, this is parallel to the anterior cortex of the tibial shaft. | FIGURE 28 However, as with coronal plane alignment, study the preoperative radiographs to determine the appropriate alignment. Full length tibia radiographs, or hip/knee/ankle radiographs, may be necessary to assist in this assessment.

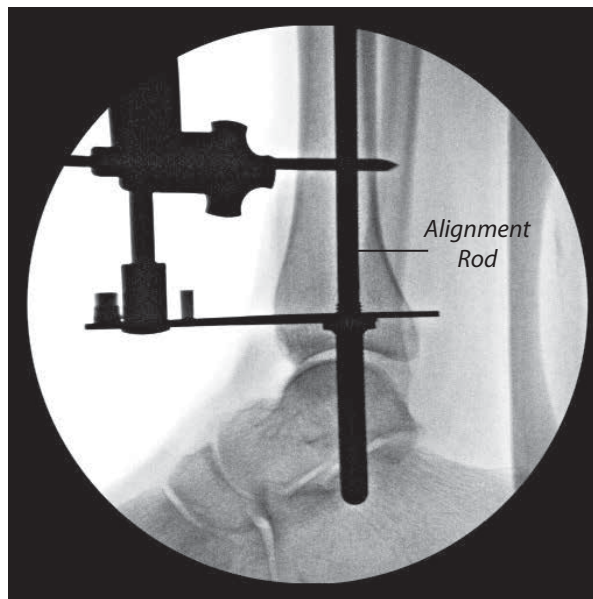

After adjustments are set, use the Hex Driver to lock both proximal and distal (aqua-colored) adjustment knobs by securely tightening them. | **FIGURE 29**

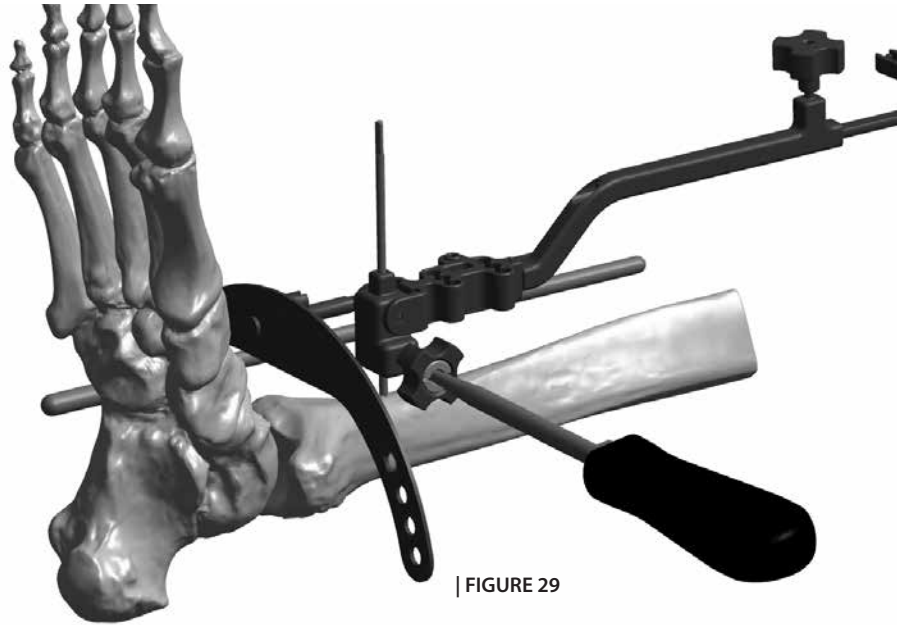

Install Sizing and Resection Guide Adjustment Block

Place two Pin Sleeves (33600025) into the two aligned holes that provide the optimal bone purchase. Typically (but not always) these will be the two center holes. | FIGURE 30

CAUTION: The two holes chosen must align with one another e.g. both center holes, both medial holes or both lateral holes.

Insert the Trocar (33600026) through each of the Pin Sleeves to create entrance portals for the percutaneous pins. | FIGURE 31



| FIGURE 30

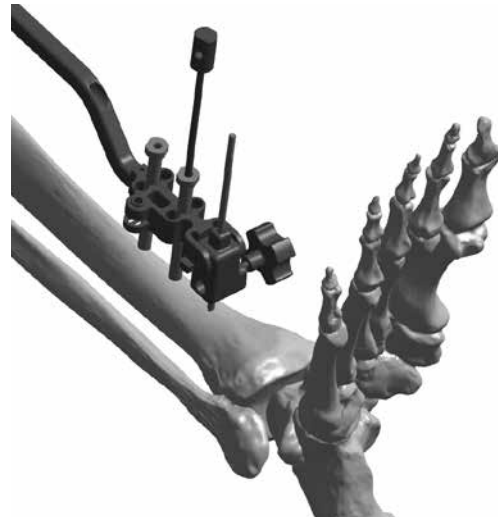

| FIGURE 31

Install a 3.2mm Pin into each Pin Sleeve and through both cortices of the tibia. | FIGURE 32 Remove both Pin Sleeves, loosen the two aqua colored knobs, and remove the Alignment Frame. Remove the proximal tibial pin (or Knee Bracket), as well as the most distal tibial pin, leaving the two parallel pins in place. | FIGURE 33



Pin Sleeve
33600025

Trocar
33600026

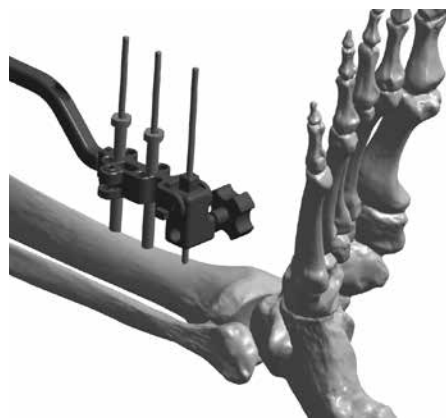

| FIGURE 32



| FIGURE 33

Coronal Plane Sizing and Positioning

Place the Adjustment Block (33600030) on the two parallel tibial pins, and lock it in place a few millimeters above the surface of the tibial crest. | **FIGURE 34** It is important not to rest the Block directly on the tibia as it may not freely translate into the desired position. Lock the Adjustment Block into this position by tightening the gray side knob with the Hex Driver. | **FIGURE 35**

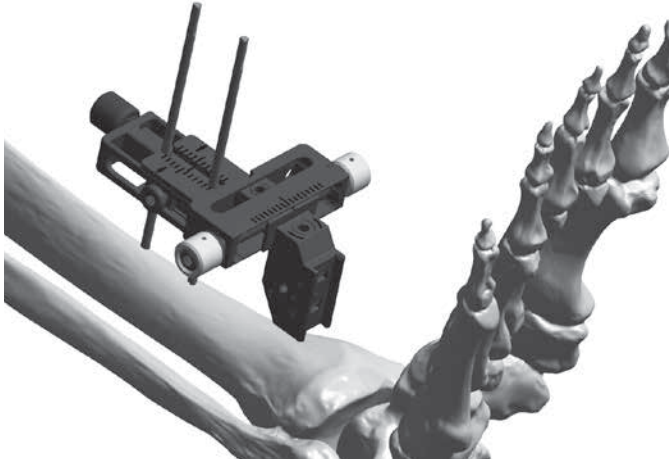

| **FIGURE 34**

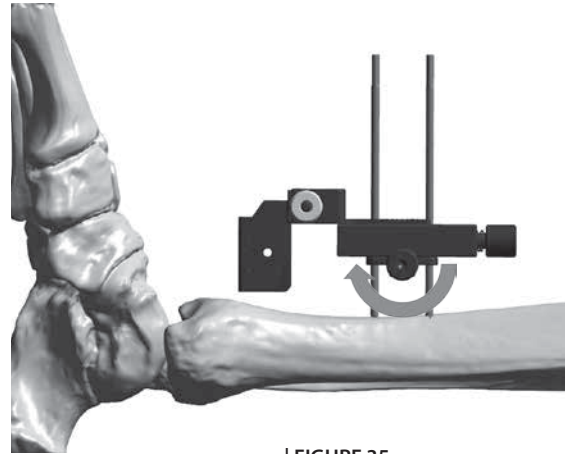

| **FIGURE 35**

Connect the Coronal Sizing Guide (33620032 through 33620035) to the Adjustment Block by sliding it onto the dovetail opening. Allow the Guide to slide into the dovetail until it rests against the surface of the tibia. Then, raise the Guide to leave 1mm of clearance between the Guide and the tibial plafond. Lock into place with the Hex Driver. | **FIGURE 36**



Adjustment Block
33600030



Coronal Sizing Guide
33620032 - 33620035

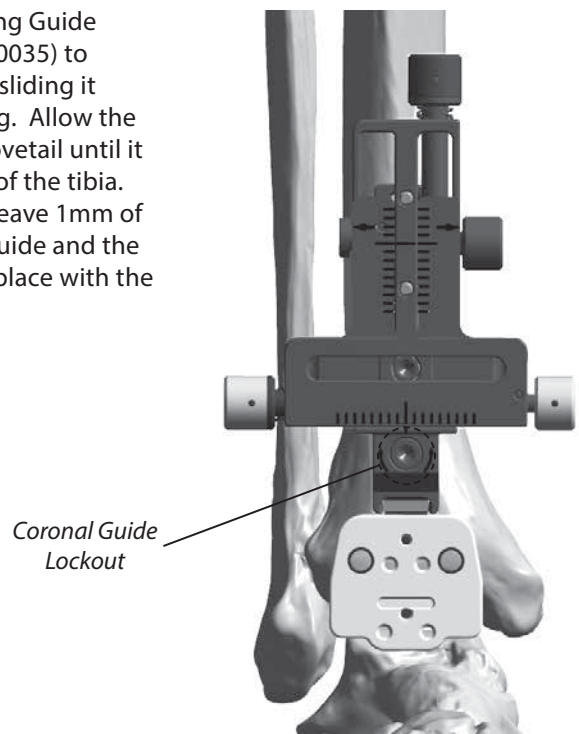

| **FIGURE 36**

To correct for parallax, the Coronal Adjustment Guide contains a “pin-in-circle” feature. The c-arm should be adjusted so that the pin appears in the center of the circle. | FIGURES 37 and 38



Correct



*Incorrect -
“Tilt” c-arm to
adjust*



*Incorrect -
“Rainbow” c-arm
to adjust*



| FIGURE 38

| FIGURE 37

Once fluoroscopic alignment is established, use the Adjustment Block to translate the Coronal Sizing Guide to the center of the joint. The purple knob will translate the Guide proximal to distal and the green knobs will translate the Guide medial to lateral. After adjustments are set, use the Hex Driver to lock both positions. | **FIGURE 39**

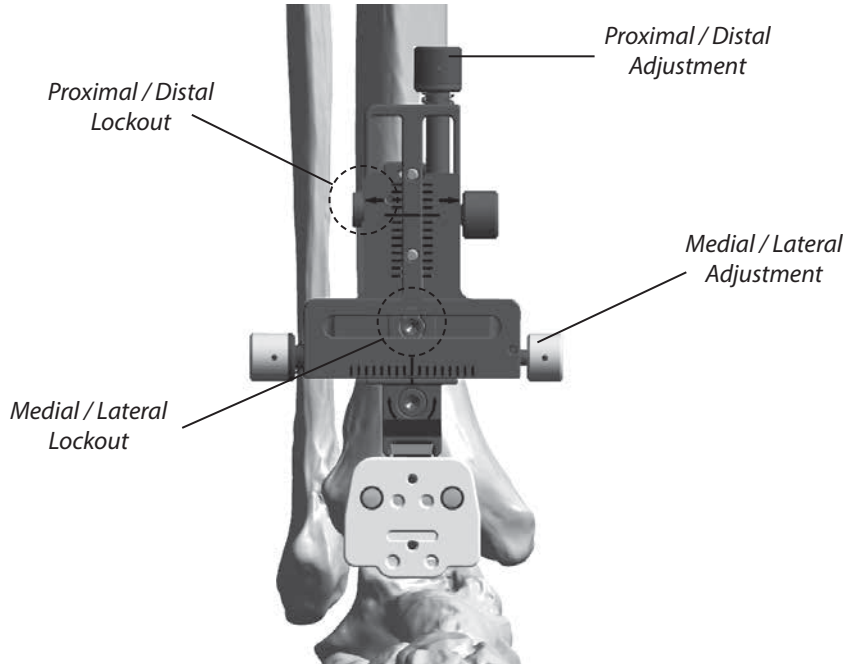

| **FIGURE 39**

The dark outlines in the Coronal Sizing Guide represent the tibial and talar bone resections, as well as the coronal profile of the tibial component.

| **FIGURE 40**

CAUTION: For proper evaluation, the ankle must be positioned at 90°.

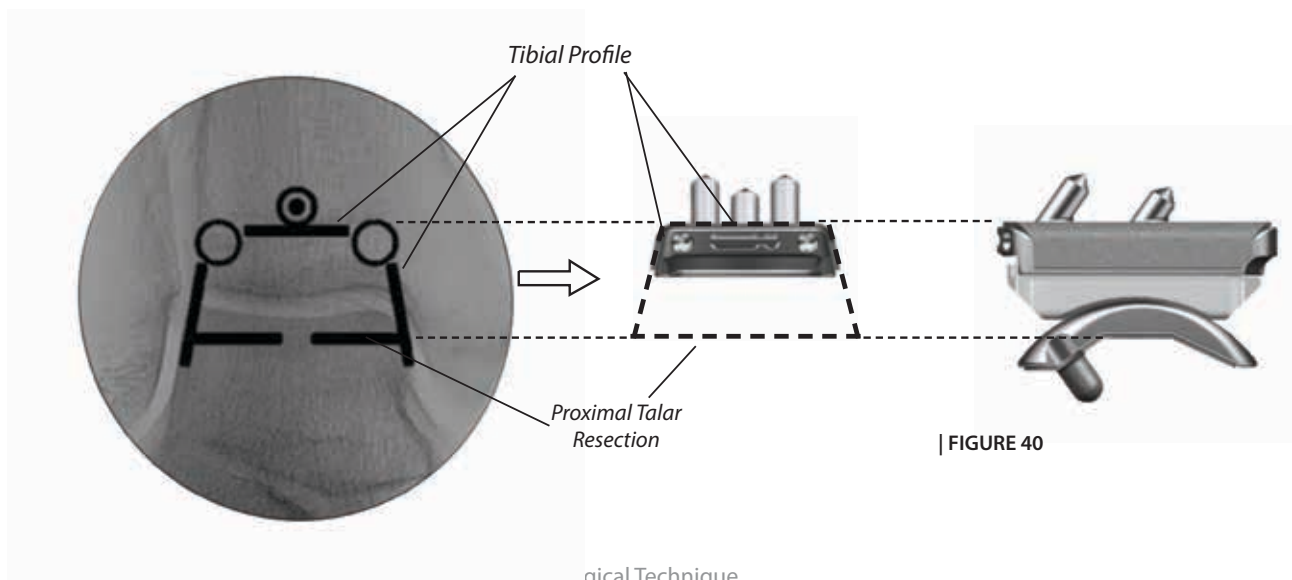

| **FIGURE 40**

Sagittal Plane Sizing and Resection Height

Slide the Sagittal Sizing Ratcheting Arm (33600068) onto the Sagittal Sizing Guide Arm (33600040) and install the Guide Arm into the Coronal Sizing Guide. Next slide the appropriately sized Sagittal Sizing Guide (33620042 through 33620045) onto the Ratcheting Arm. | **FIGURE 41** Attach the Sagittal Sizing Guide Assembly to the Coronal Guide by inserting the metal tab of the Guide Arm into the open slot of the Coronal Guide. | **FIGURE 42**

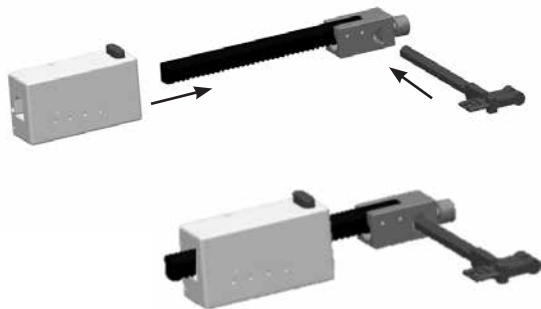

| FIGURE 41

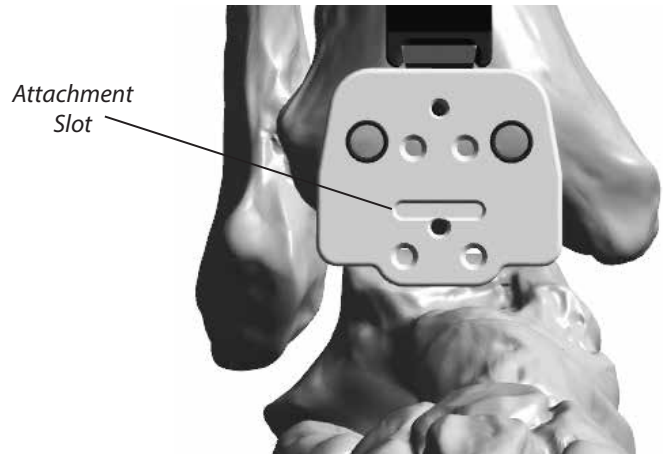

| FIGURE 42

To minimize parallax distortion and magnification error, the Sizing Guide should be oriented on the side of the ankle closest to the c-arm receiver, and the Sagittal Sizing Guide should be placed as close to the bone as possible. | **FIGURE 43** Ideally the c-arm should be situated on the same side of the bed as the ankle being replaced, in order to allow the ankle to be placed as close to the receiver as possible.

Sagittal Sizing Ratcheting Arm
33600068

Sagittal Sizing Guide Arm
33600040

Sagittal Sizing Guide
33620042 - 33620045

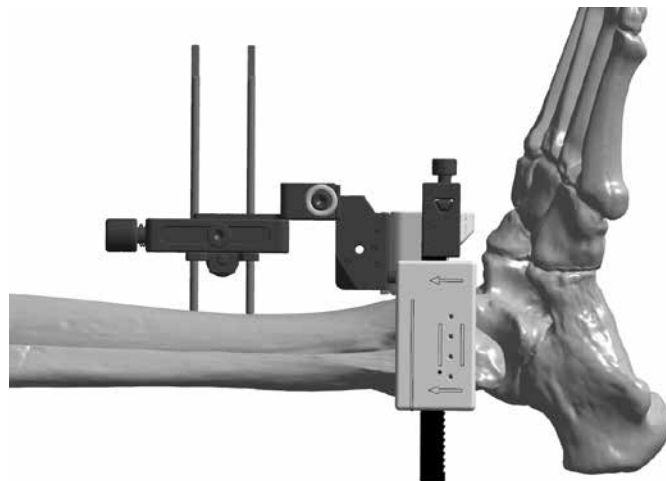

| FIGURE 43

To fluoroscopically obtain a true lateral view, ensure that the center row of talar alignment pins appear as true solid circles. | **FIGURE 44** These pins must be viewed “end on” to prevent misinterpretation of the fluoroscopic image.

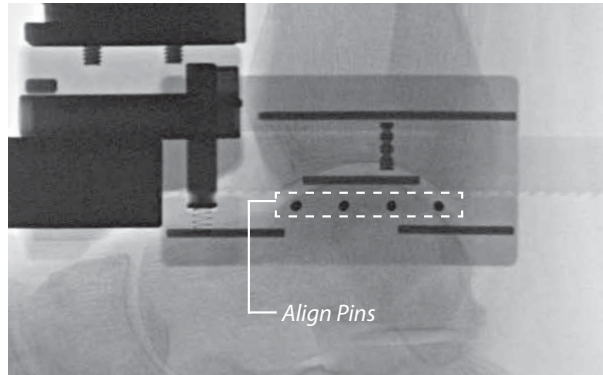

| **FIGURE 44**

Make c-arm adjustments as necessary in order to avoid parallax distortion. | **FIGURES 45 and 46**

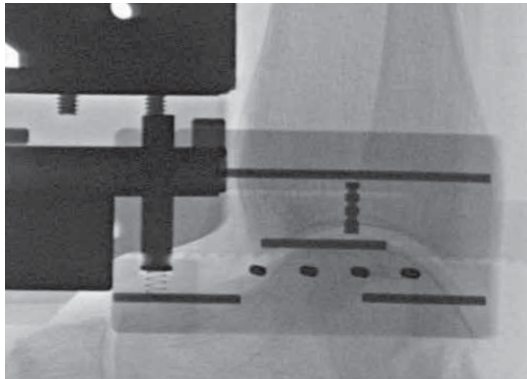

Rotate or “Rainbow” c-arm to adjust | **FIGURE 45**

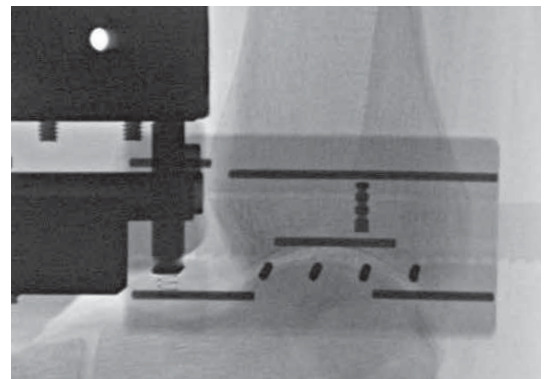

Swing or “Wig-Wag” c-arm to adjust | **FIGURE 46**

As an additional fluoroscopic check a 2.4 Steinmann Pin can be placed through the center hole of the Coronal Alignment Guide. | **FIGURE 47** In a lateral plane fluoroscopic image this pin will indicate the height of the proximal talar resection and in a true lateral view should be inline with the row of alignment pins in the Sagittal Guide. | **FIGURE 48**

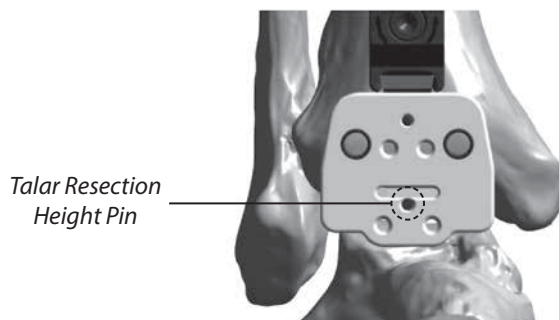

| **FIGURE 47**

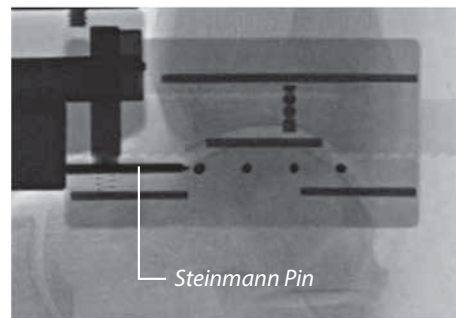

| **FIGURE 48**

The Sagittal Sizing Guide is used to fluoroscopically set the proximal extent of the tibial resection, and distal extent of the talar resection. The Sizing Guide contains fluoroscopic indicators that correspond to the tibial resection, joint line (top of the talar dome), height of the proximal talar resection, and the distal extent of the anterior chamfer. The Sizing Guide also has an indicator for the anterior to posterior dimension of the tibial implant. | FIGURES 49 and 50

Turn the purple knob of the Adjustment Block to achieve the desired resection height. Position the guide so the proximal edge of the "joint line" pin aligns with the proximal extent of the talar bone or the desired location of the reconstructed joint line. | FIGURES 49 and 50

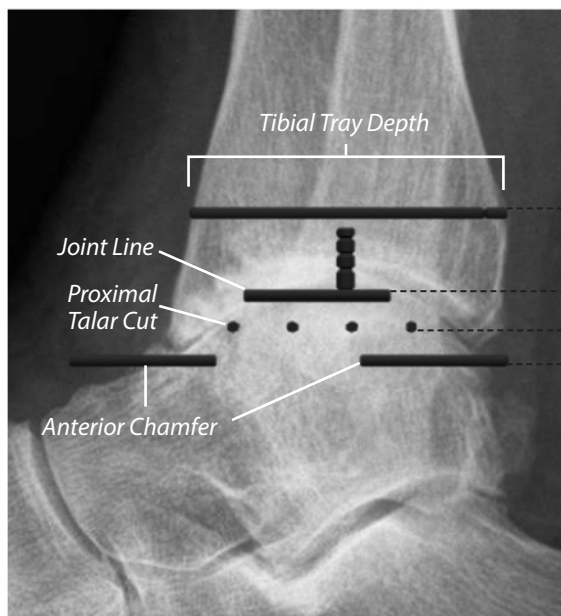

| FIGURE 49



| FIGURE 50

CAUTION: For proper evaluation the ankle must be positioned at 90°.

Study the talus carefully, and if it is not in the 90° position due to posterior contracture, the surgeon should lengthen the Achilles tendon and remove anterior impinging osteophytes.

Multiple component sizes can be evaluated by replacing both corresponding Coronal and Sagittal Sizing Guides.

Note that the distal extent of the anterior chamfer also corresponds to the flat cut surface of an INBONE® talar dome. | FIGURES 51 and 52

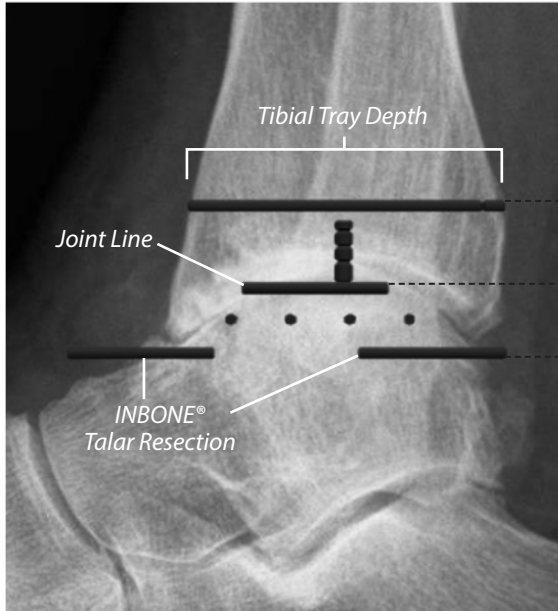

| FIGURE 51



| FIGURE 52

The Sagittal Sizing Guide also has a proximal/distal tibial resection depth indicator for evaluating the amount of tibial resection. In addition, there is a notch in the tibia tray A/P length marker that allows the surgeon to evaluate whether a standard or long sized tibia tray may be required. | FIGURE 53



| FIGURE 53

Drill Tibial Corners

For steps on how to utilize a flat-cut INBONE® Talar Dome instead of the standard chamfer-cut INFINITY® Talar Dome refer to Appendix A.

If any translational adjustments were made it is recommended to take a final AP fluoroscopic image to confirm coronal positioning.

Ensure that all Adjustment Block positions are secured with the Hex Driver and place four 2.4mm Steinmann Pins (200072) into the Coronal Sizing Guide.

| **FIGURE 54** Place the two tibial pins first then place the talar pins.

CAUTION: During installation of the distal talar pins it is critical that the ankle be positioned at 90°

Using the Tibial Corner Drill (33600048), bi-cortically drill both proximal corners of the tibia. | **FIGURE 55**

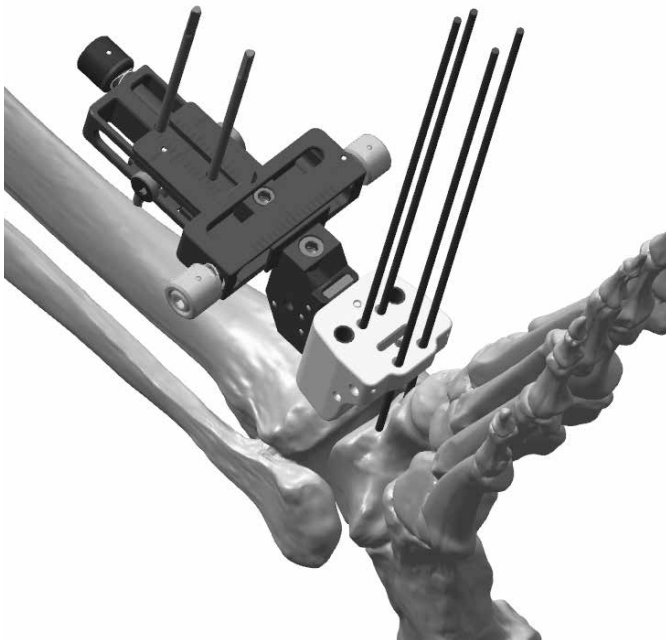

| **FIGURE 54**

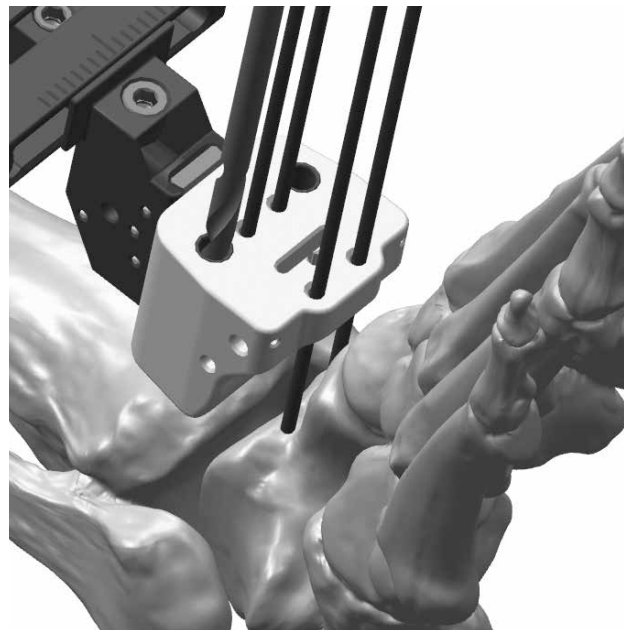

| **FIGURE 55**



Tibial Corner Drill
33600048

Bone Resection

Remove the Coronal Sizing Guide and slide the appropriately sized Resection Guide (33620052 through 33620055) over the 2.4mm Pins and into the Adjustment Block. | **FIGURE 56** Secure with Hex Driver.

Install a 2.4mm Steinmann Pin into each gutter location. Using the Pin Cutter trim the Pins flush to the surface of the Resection Guide. | **FIGURE 57**

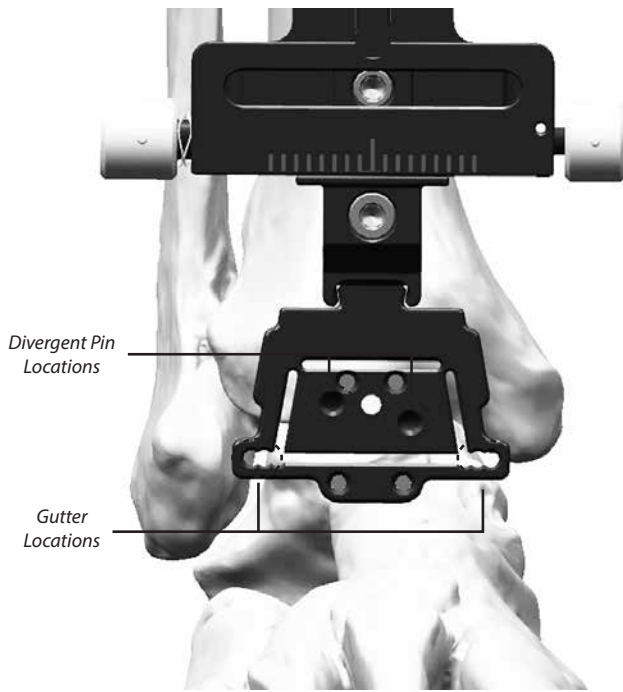

| **FIGURE 56**



| **FIGURE 57**



Resection Guide
33620052 – 33620055



Pin Cutters
200427

Optionally, for additional stability, install a 2.4mm Pin through one of the two divergent pin locations. | **FIGURE 57** When using a divergent pin always use the medial option (in which the pin travels medial to lateral). This will help avoid the neurovascular bundle posterior to the medial malleolus. Cut the pin leaving enough length to allow its later removal with a pin driver or pin puller but short enough to allow saw blade clearance in the medial resection slot (approximately 15mm).

Using the appropriately sized Saw Blade and oscillating bone saw make the tibial and talar bone resections. This includes cutting through the proximal, distal, medial and lateral slots of the Resection Guide.

Remove the divergent Steinmann Pin then remove the Resection Guide, Adjustment Block and remaining Steinmann Pins. Check that the talar resection is complete by using a 1/2 inch osteotome. Complete the cut if necessary and gently lever the resected bone out anteriorly.

Optionally, to facilitate removal of the remaining posterior tibia, the Corner Chisel (33600058) and a mallet can be used to finish off bone cuts in the proximal corners of the resected tibia. | **FIGURE 58** The Corner Chisel is laser marked to indicate the anterior to posterior depth of the various size tibial trays.

CAUTION: Care must be taken to ensure that the Corner Chisel does not penetrate too deeply, as neurovascular injury may occur. Do not rely solely on the depth indications on the Chisel to determine resection depth. If unsure, utilize a lateral fluoroscopic image to confirm proper depth of the chisel.

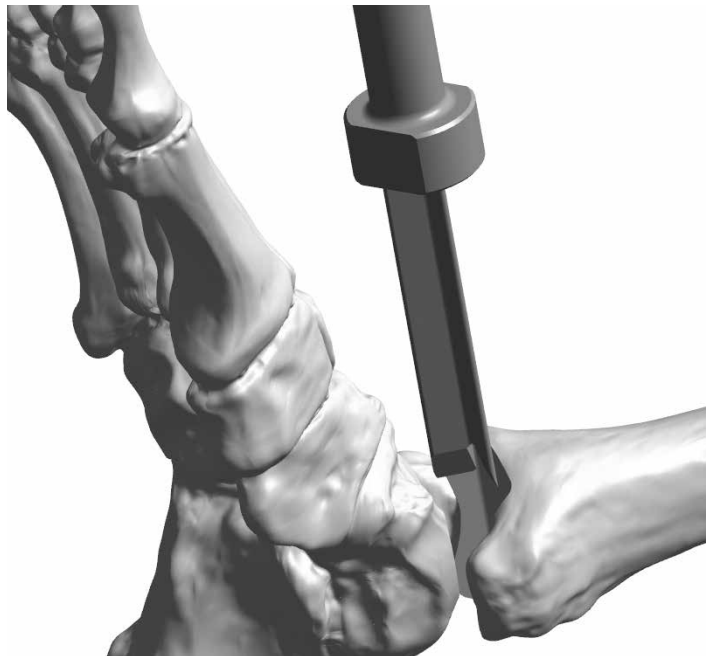

| **FIGURE 58**



Corner Chisel
33600058

Remove Tibial Bone Resection

Using a pin driver, insert the Bone Removal Screw (IB200051) into the resected tibial bone. Attach the Ratcheting Handle (44180025) to the Bone Removal Screw to aid in removing the remaining tibial section through traction.

| FIGURE 59



| FIGURE 59



*Bone Removal Screw
IB200051*



*Ratcheting Handle
44180025*



*Posterior Capsule
Release Tool
IB200050*

Insert the 90° Posterior Capsule Release Tool (IB200050) into the joint space and use to free up the posterior capsule soft tissues attachments to the resected tibia. | FIGURES 60 and 61

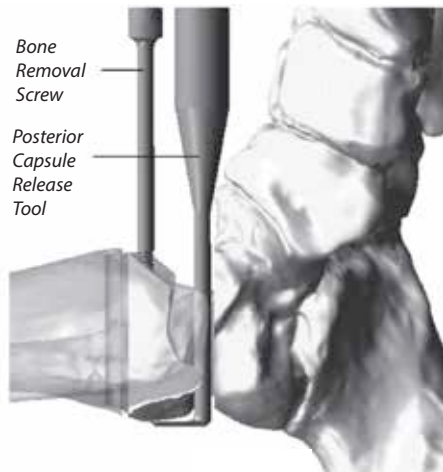

| FIGURE 60



| FIGURE 61

Tibial Tray Trialing and AP Sizing

Remove Tibial Bone Resection. A reciprocating saw or bone rasp may be used to remove any excess bone, taking care to follow the previously made cut line. Remove loose bone pieces and irrigate the joint space. | **FIGURE 62**



| **FIGURE 62**



| **FIGURE 63**



Tibial Tray Trial
33620062 - 33620065



Self-Retaining Laminae Spreaders
33609012

Place the appropriately sized Tibial Tray Trial (33620062 through 33620065) into the resected joint space and seat flush against the resected tibia. Padded Self-Retaining Laminae Spreaders (33609012) can be inserted between the Trial and the talus to ensure the Trial is seated flush. | **FIGURE 63** Also ensure the Tibial Trial is fully seated against the anterior cortex of the tibia | **FIGURE 64** and secure in place using two 2.4mm Steinmann Pins. | **FIGURE 65**

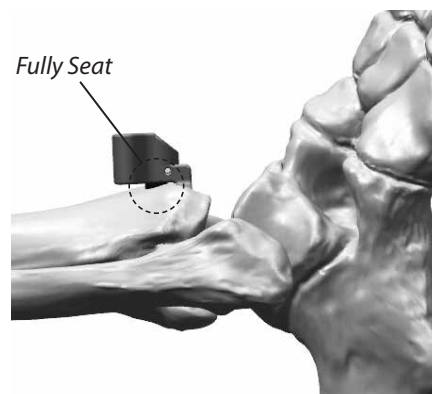

| **FIGURE 64**



| **FIGURE 65**

The Tibial Tray Trial is also used to check the tibial cut surfaces and ensure that no bone fragments will impede proper positioning of the Tibial Tray. Remove excess bone and irrigate as necessary.

The Tibial Trial allows the surgeon to determine both the optimal AP tibial coverage and positioning through fluoroscopic evaluation. | **FIGURE 66**

For sizes 3 through 5 the surgeon has the option to choose either a standard or long AP sized tibial tray. The notch in the Tibial Trial indicates the length of the “standard” option. | **FIGURES 67 and 68**

Tibia component sizes 1 and 2 are each available in only one AP length. Because they share the same ML dimension, they utilize the same Tibial Trial. When using the size 1&2 Tibia Trial the full length represents the size 2 and the notch indicates the length of the size 1 option.



| **FIGURE 66**

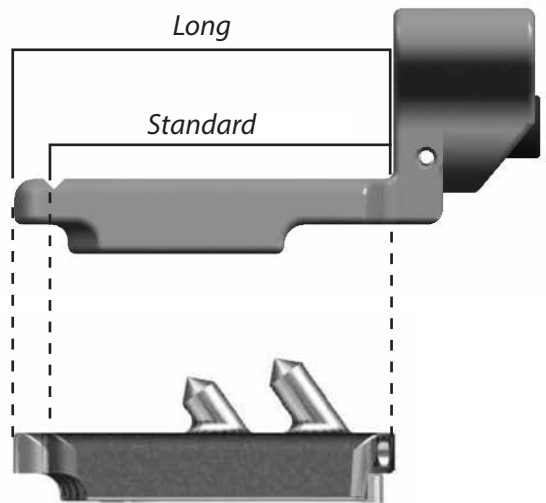

| **FIGURE 67**

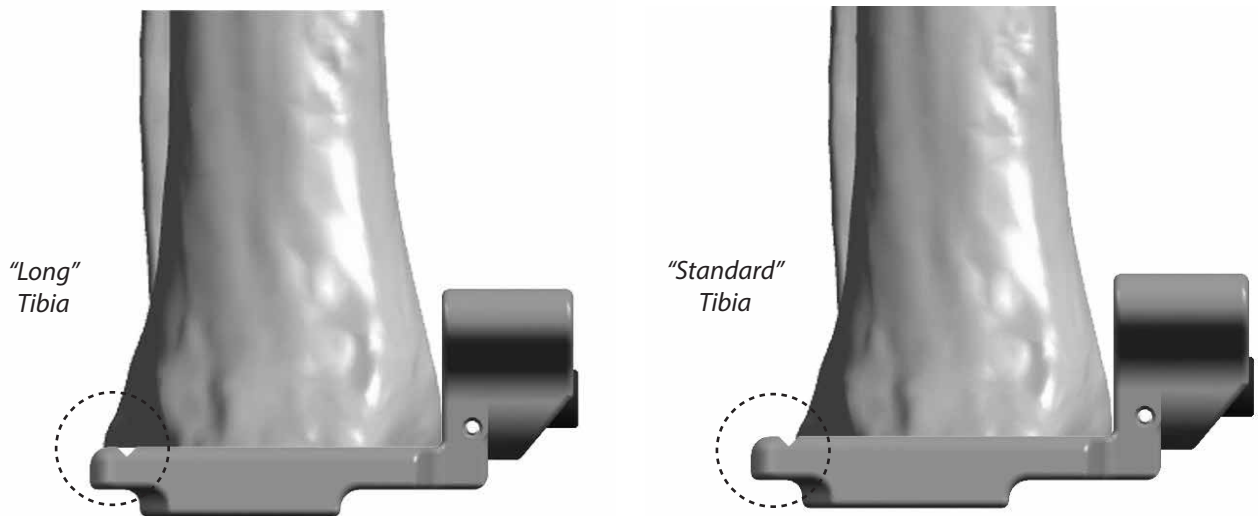

| **FIGURE 68**

The surgeon also has the option to anteriorly translate the Tibial Trial (maximum of 3mm) in order to minimize posterior overhang if desired. | **FIGURE 69** To adjust, insert the Hex Driver into the front of the Tibial Trial and turn clockwise. | **FIGURE 70 and 71**

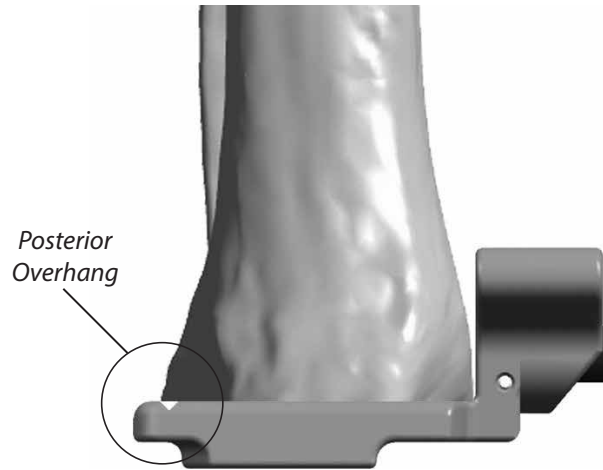

| **FIGURE 69**



| **FIGURE 70**

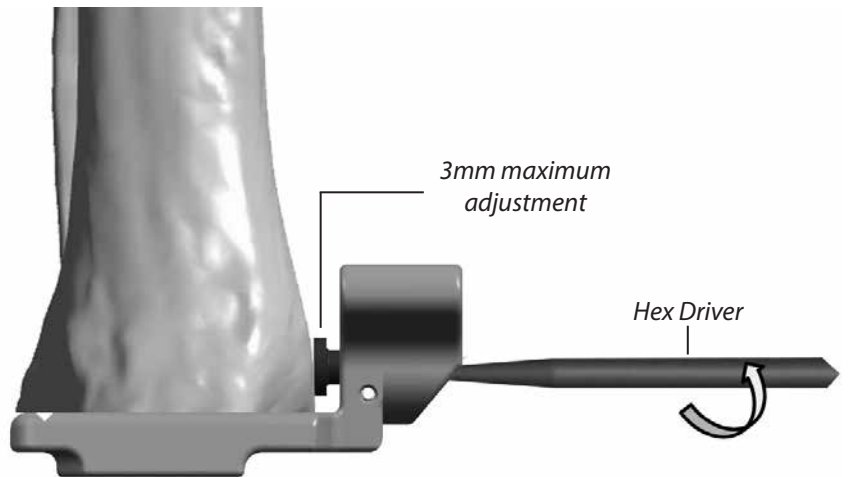

| **FIGURE 71**

Tibial Peg Broaching

Cut the Steinmann Pins to the surface of the Tibial Tray Trial. Using the Posterior Tibial Peg Broach (33600069), prepare a hole in the resected tibia by malleting the Broach through the posterior opening of the Trial. | **FIGURE 72** Temporarily leave the Posterior Broach in place while the two anterior holes are prepared.



| **FIGURE 72**

Using the Anterior Tibial Peg Broach (33600067), prepare the two anterior holes through the Trial. | **FIGURE 73**



| **FIGURE 73**

After all three holes are prepared, remove both Broaches and leave the Tibial Tray Trial in place. | **FIGURE 74**



*Posterior Tibial Peg Broach
33600069*



*Anterior Tibial Peg Broach
33600067*

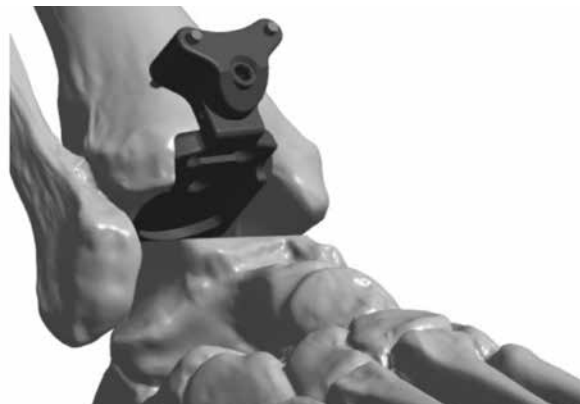

| **FIGURE 74**

Talar Component Sizing and Positioning

Place the appropriately sized Talar Dome Trial (33600071 through 33600075) into the joint space. Using the Poly Insert Trial Holding Tool (IB200110), install the appropriately sized Poly Insert Trial (33621106 through 33625512) into the Tibial Tray Trial. The locking tab of the Poly Insert Trial should engage the Tibial Tray Trial. | **FIGURE 75**

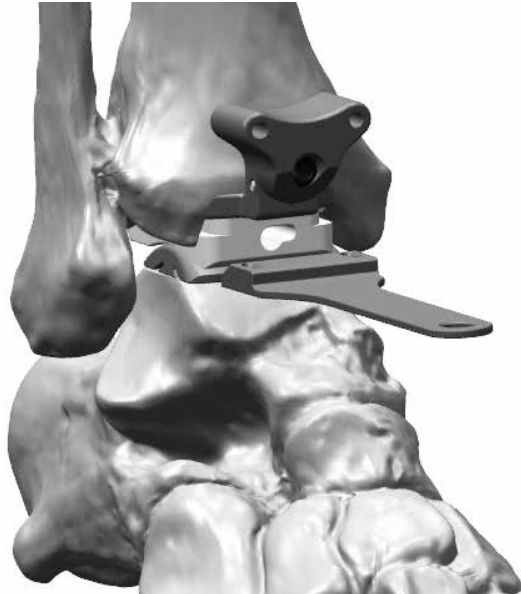

| **FIGURE 75**

The surgeon has two options for the Talar Dome implant size at this juncture: either the matching size for the implanted Tibial Tray, or one size smaller. It is beneficial to assess both sizes under A/P and lateral fluoroscopic images. Please note that the A/P image is critical for sizing the talar component, as the surgeon's goal is to minimize overhang of the talar component, and thus minimize prosthetic impingement in the medial and lateral gutters of the ankle joint.



Talar Dome Trial
33600071 - 33600075

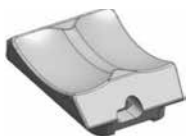

Poly Insert Trial
33621106 - 33625512

For steps on how to make a 2mm talar re-cut refer to Appendix B.

Under sagittal plane fluoroscopy, ensure the posterior portion of the Talar Trial is resting on the posterior portion of the patient's residual talus (establish congruence). | FIGURES 76 and 77

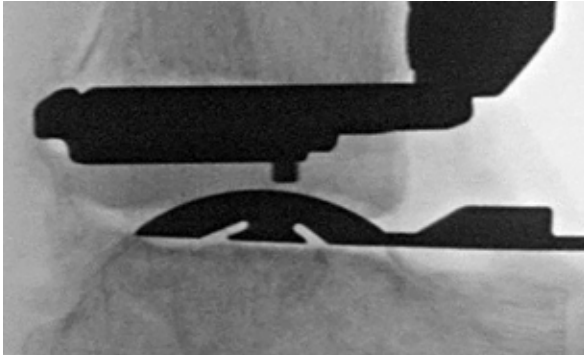

| FIGURE 76

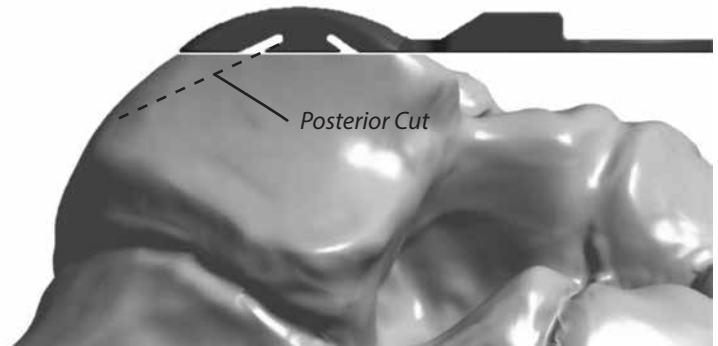

| FIGURE 77

To accurately perform the range of motion, place some axial compression on the components to maintain position, and flex and extend the ankle. The surgeon will observe the talar component rotating into the anatomic position for this particular patient, establishing the center of rotation for the ankle. Note that the surgeon must not only be cognizant of the talar position in the sagittal plane, but must simultaneously maintain medial/lateral coverage as evidenced by the previous A/P plane fluoroscopic views.

Once the Talar Dome Trial has settled into optimum anatomical position, hold the foot in place and install two 2.4mm Steinmann Pins through the Talar Dome Trial to temporarily hold it in place. | FIGURE 78

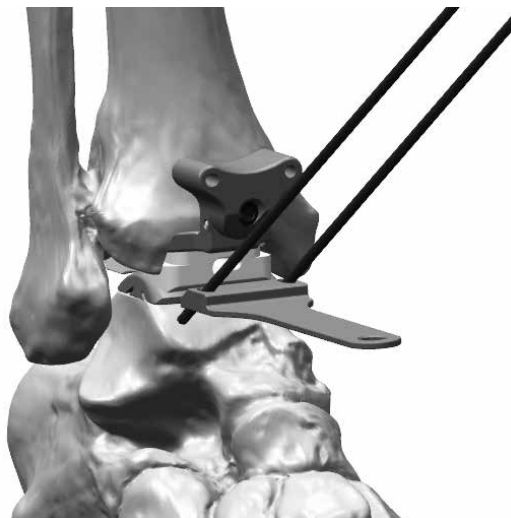

| FIGURE 78

Talar Chamfer Resections

Using the Poly Insert Trial Holding Tool, remove the Poly Insert Trial. Slide the Talar Dome Trial off the 2.4mm pins in the talus and slide the Tibial Tray Trial off the 2.4mm pins in the tibia. | **FIGURE 79** The two 2.4mm tibial pins may now be removed as well.

Slide the Talar Resection Guide Base (33600091 through 33600095) onto the two 2.4mm pins in the talus and seat flush to the resected talar surface. | **FIGURE 80**



| **FIGURE 79**



| **FIGURE 80**

Using the T-Handle Pin Driver (33600120), or power drill install two Temporary Fixation Screws (33610002 or 33610003) through the Talar Resection Guide Base into the talus. | **FIGURE 81**



Talar Resection Guide Base
33600091 - 33600095



T-Handle Pin Driver
33600120



Temporary Fixation Screw
Long - 33610002
Short - 33610003

CAUTION: When installing the Temporary Fixations Screws, care must be taken to avoid over torquing. It is recommended to install the Screws to 3/4 of their entire depth under power, finishing with the T-handle, to avoid inadvertent breakage.



| **FIGURE 81**

Using the appropriately sized Saw Blade and oscillating or reciprocating bone saw, make the posterior talar chamfer resection through the slot in the Talar Resection Guide Base. | **FIGURE 82**

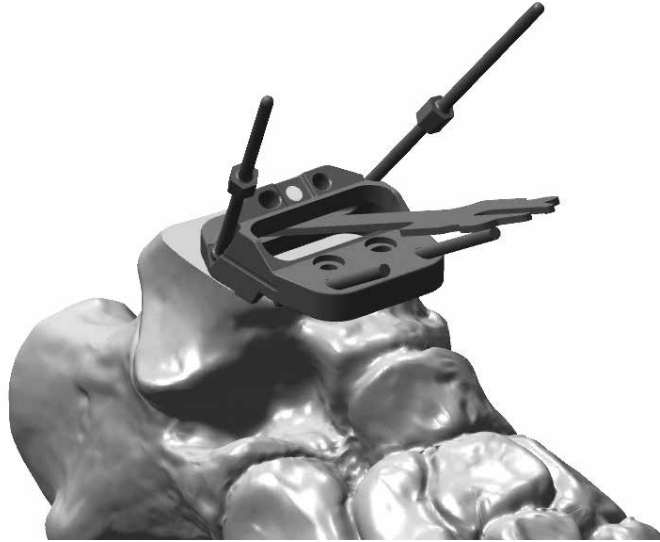

| **FIGURE 82**

Remove the two anterior 2.4mm Pins. One of these pins can then be installed through the anterior pin hole in the Guide Base to provide additional fixation during the talar preparation steps. Cut this pin flush to the surface of the Guide Base to prevent interference with the saw blades and reamers. | **FIGURE 83**



| **FIGURE 83**

Assemble the Anterior Talar Pilot Guide (33600101 through 33600105) with pegs facing down onto the anterior face of the Talar Resection Guide Base. | **FIGURE 84**

Use the appropriately sized Talar Reamer (33600123 or 33600126) to plunge cut through all four holes of the Pilot Guide. | **FIGURE 85** This will prepare the talar surface for the anterior flat of the talar component.



| **FIGURE 84**

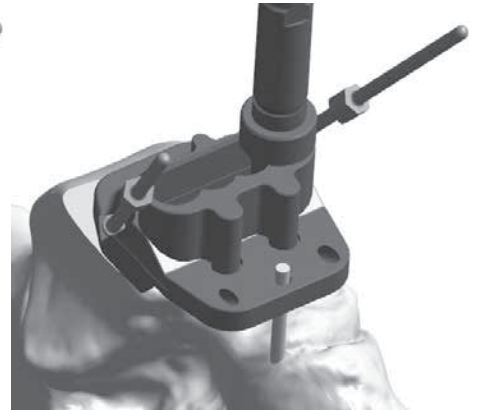

| **FIGURE 85**

Remove the Pilot Guide and replace with the Anterior Talar Finish Guide (33600111 through 33600115). | **FIGURE 86**

Use the Talar Reamer to perform the finishing cuts for the anterior talar flat by sliding the Reamer from side to side within the Finish Guide. | **FIGURE 87** To ensure bone cuts are at the proper depth, make sure the shoulder of the Reamer is flush against the guide for each reaming step.



Anterior Talar Pilot Guide
33600101 - 33600105



Talar Reamer
Size 1-3 - 33600123
Size 4-5 - 33600126



Anterior Talar Finish Guide
33600111 - 33600115

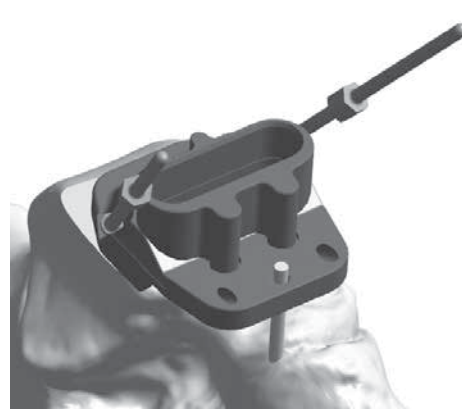

| **FIGURE 86**

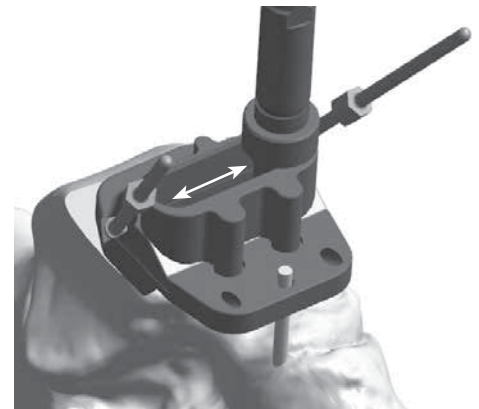

| **FIGURE 87**

Remove the Finish Guide and reassemble the Pilot Guide onto the Talar Resection Guide Base. The Pilot Guide will now be rotated 180° from the previous steps. | **FIGURE 88**

Again use the Talar Reamer to plunge cut through all four holes of the Pilot Guide. | **FIGURE 89** This will prepare the talar surface for the anterior chamfer of the talar component.



| **FIGURE 88**



| **FIGURE 89**

Remove the Pilot Guide and assemble the Finish Guide to complete the preparation of the anterior chamfer. | **FIGURE 90**

Using the Talar Reamer, perform the finishing cuts for the anterior talar chamfer by sliding the Reamer from side to side within the Finish Guide. | **FIGURE 91**



| **FIGURE 90**



| **FIGURE 91**

Remove the Fixation Pins and Resection Guide Base and remove any residual bone medial and lateral to the prepared chamfer cuts using either an osteotome or rongeur. | FIGURE 92

CAUTION: Failure to adequately remove residual bone from resected edges may lead to improper seating of the talar component.

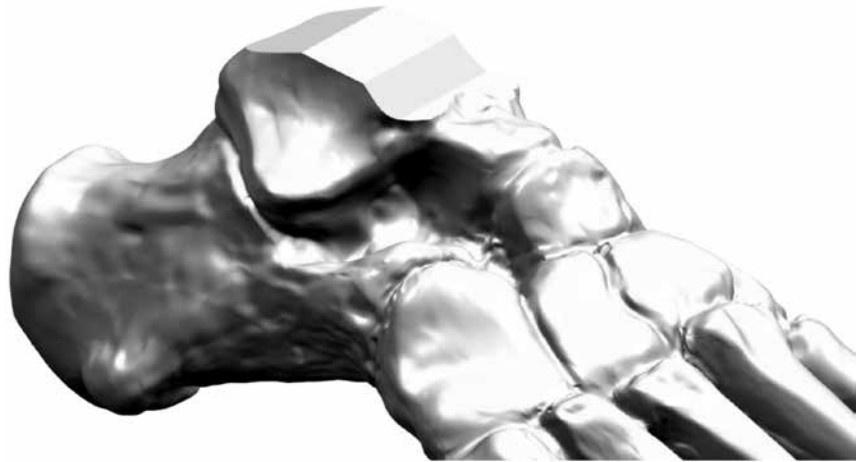

| FIGURE 92

Polyethylene Thickness

While the final polyethylene thickness does not have to be definitively chosen during the trial phase, it is important to have what is perceived to be the appropriately sized trial poly to accurately determine the placement of the talar component. The trial poly used for the reduction should fit appropriately to determine the center of rotation of the talar component; therefore, trialing multiple size polys may be necessary. Note that after insertion of the final talar dome, the height of the poly can and should be reassessed.

In order to determine proper polyethylene height the following factors must be considered:

- Smooth range of motion of the ankle without anterior or posterior impingement.
- Ligaments are tensioned both medially and laterally WITHOUT over-tensioning. Over-tensioning is noted when the trial talar component tilts following trial poly insertion. Alternatively, with range of motion, the talar component becomes incongruent with the trial poly, which can identify too much tension on the ankle replacement. Over-tensioned joints may cause increased polyethylene wear, and should be avoided.
- Stress the ankle joint into varus and valgus. The trial components should not tilt.
- The trial poly should engage the sulcus in the talar dome trial without allowing medial/lateral translation.

Talar Peg Drilling

Replace the Tibial Tray Trial over the 2.4mm Pins in the tibia. Insert the appropriately sized Talar Peg Drill Guide (33600161 through 33600165) into the joint space and over the resected talus. Reinstall the Poly Insert Trial into the Tibial Tray Trial and perform a trial reduction to establish optimal talar medial/lateral positioning. | **FIGURE 93**



| **FIGURE 93**

Slightly plantarflex the foot and install a 2.4mm Steinmann Pin through the Talar Peg Drill Guide to temporarily hold it in position. | **FIGURE 94**



*Talar Peg Drill Guide
33600161 - 33600165*



*Anterior Peg Drill
IB200020*

Using the 4mm Anterior Peg Drill (IB200020), drill a hole through the medial and lateral openings in the Talar Dome Trial. The drill has a hard stop designed to set the appropriate drilling depth in the talus for the Talar Dome anterior pegs. | **FIGURE 95**



| **FIGURE 94**



| **FIGURE 95**

Tibial Component Implantation

Remove the 2.4mm Pins in the talus and tibia and remove the Talar Peg Drill Guide, Poly Insert Trial, and Tibial Tray Trial from the joint space. | **FIGURE 96**

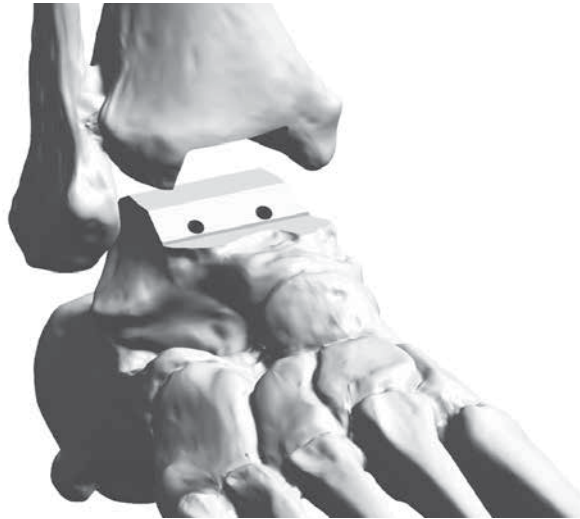

| **FIGURE 96**

Choose the appropriately sized Tibial Tray Impaction Insert (33620132 through 33620135) and assemble the Tibial Tray component by sliding over the dovetail opening and threading the two screws into the threaded holes in the anterior face of the Tibial Tray. | **FIGURE 97**

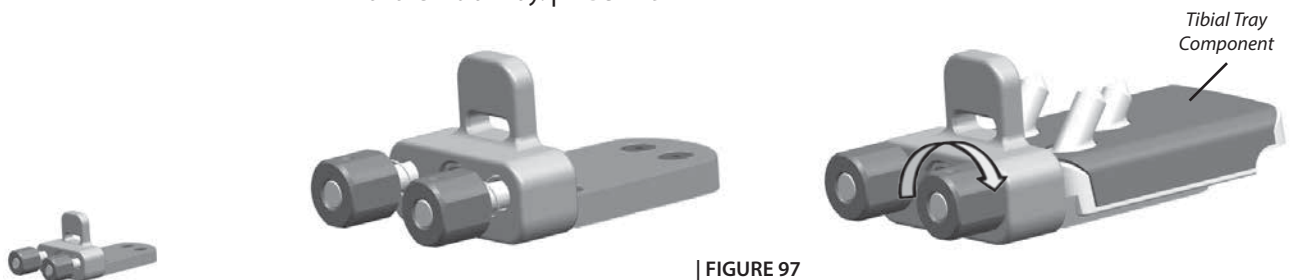

| **FIGURE 97**

*Tibial Tray
Impaction Insert
33620132 - 33620135*

Please note that older versions of Tibial Tray Impaction Inserts do not have the threaded attachments to the Tibial Tray component, but rather a small locking tab to provisionally hold it in place.

Apply bone cement to the top and side walls of the Tibial Tray component, taking care not to get any cement on the anterior face or bottom of the Tray.

CAUTION: The INFINITY® Total Ankle is intended for cemented use only.

Thread the Insertion Handle (33600130) into the front of the Tibial Tray Impaction Insert and begin insertion of the Tibial Tray component. Introduce the Tibial Tray into the joint space, ensuring all three pegs of the component are aligned with the prepared holes in the tibia. | FIGURES 98 and 99

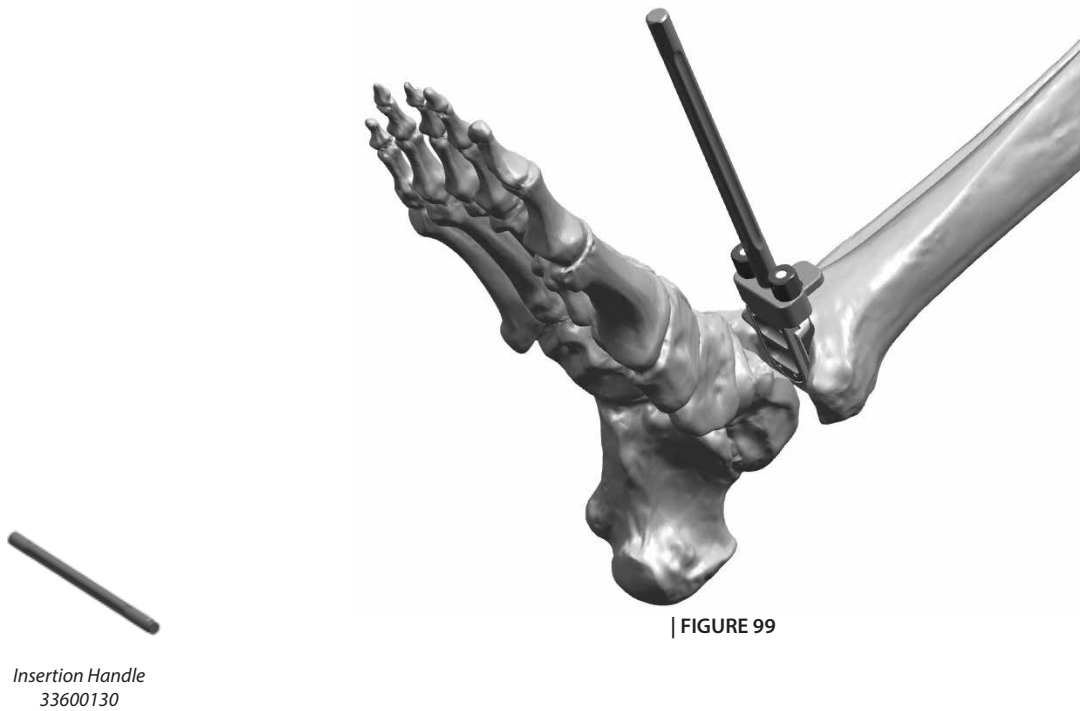
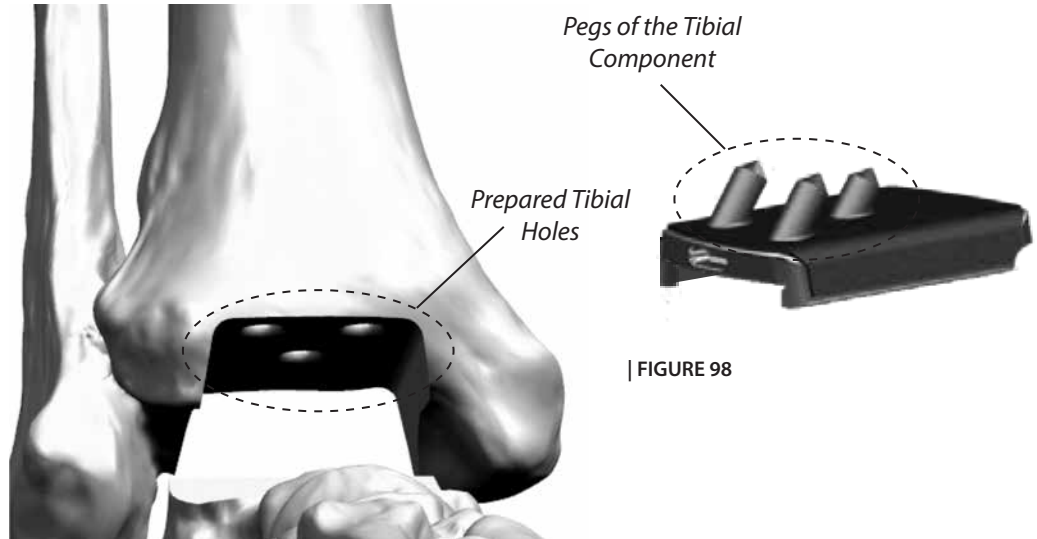

Use the Offset Tibial Tray Impactor (33600140) to complete the seating of the Tibial Tray. The Impactor handle can be used on the lateral or medial side of the foot, depending on surgeon preference. | FIGURE 100

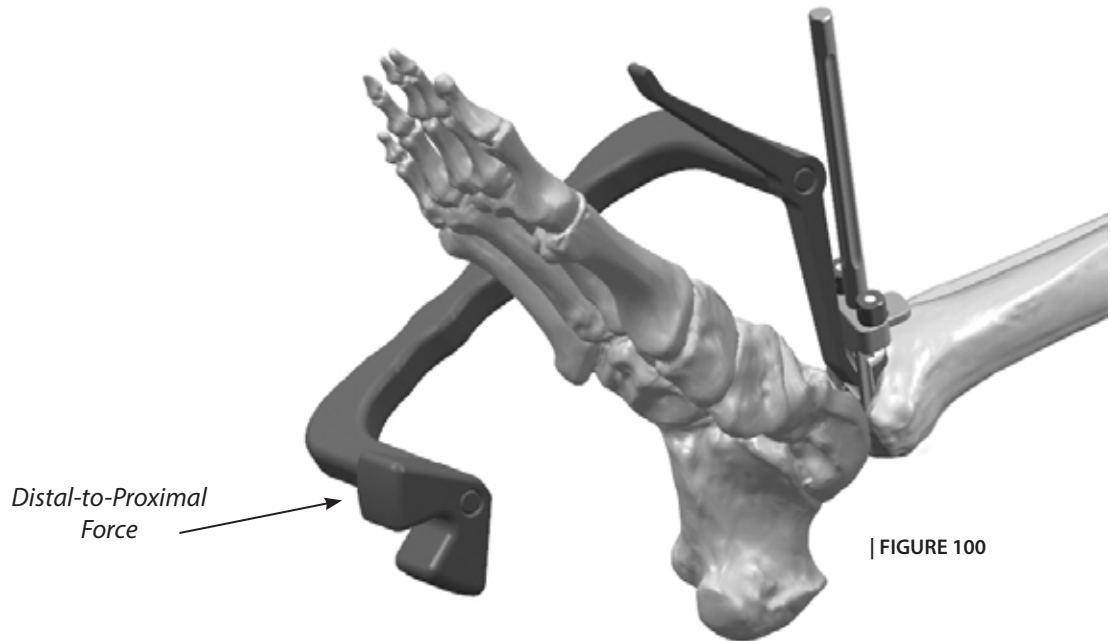

There are two impaction notch locations within the Tibial Tray Impaction Insert, one anterior and one posterior. For optimal results, proceed slowly, beginning with the posterior notch and alternating between both impaction points. Verify progress via fluoroscopic imaging.



Offset Tibial
Tray Impactor
33600140

The Straight Tibial Tray Impactor (33600141) can also be used to help seat the Tibial Tray using an impaction force in line with the angled tibial tray pegs.



Straight Tibial
Tray Impactor
33600141

CAUTION: It is important that the anterior surface of the tibial tray contacts and sustains load upon the anterior tibial cortex with weight bearing. Striking the Impactor with excessive force, or continuing to strike the Impactor after the Tibial Tray is fully seated, can result in the Tibial Tray pegs plowing through cancellous bone, leaving the Tibial Tray posteriorly translated from the anterior tibial cortex.

Talar Component Implantation

Insert the appropriately sized Tibial Tray Protector (33620152 through 33620155) into the Tibial Tray to protect the Talar Dome surface during installation. | **FIGURE 101**



| **FIGURE 101**

Apply bone cement to the bottom surface of the Talar Dome.

CAUTION: The INFINITY® Total Ankle is intended for cemented use only.

Start insertion of the Talar Dome component into the joint space by hand to ensure the talar pegs align with the drilled holes in the talus. Remove the Tibia Tray Protector and insert the assembled Talar Dome Impactor (IB200030 and IB200031), aligning tip with the sulcus of the Talar Dome. | **FIGURE 102** With the ankle in plantar flexion, strike the Impactor to seat the talus posteriorly first, followed by final seating with a direct vertical force, being careful not the lever on the seated tibial base plate.

Utilize a lateral fluoroscopic image to verify that the component is fully seated. | **FIGURE 103**



| **FIGURE 102**



| **FIGURE 103**



Tibial Tray Protector
33620152 - 33620155



Talar Dome Impactor
IB200030
Impactor Tip
IB200031

Polyethylene Bearing Installation

Install two Attachment Screws (33600190) into the anterior face of the Tibial Tray.
| FIGURE 104



| FIGURE 104

Assemble the Poly Insert Guide Rail (33600172 through 33600175) onto the Poly Inserter (33600170) and ensure that the plunger handle is pulled back completely and locked in the start position. | FIGURE 105

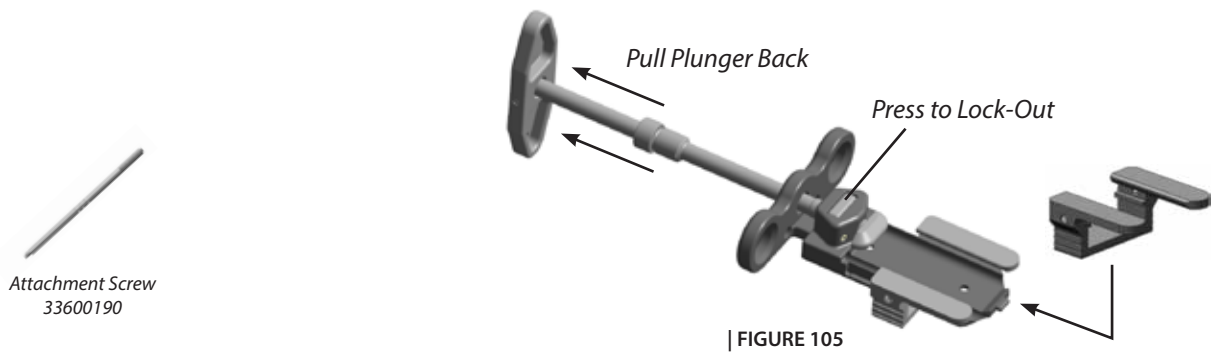

Slide the dovetail feature of the Poly Insert Implant into the Poly Insert Guide Rail, ensuring correct A/P orientation of the component. | FIGURE 106

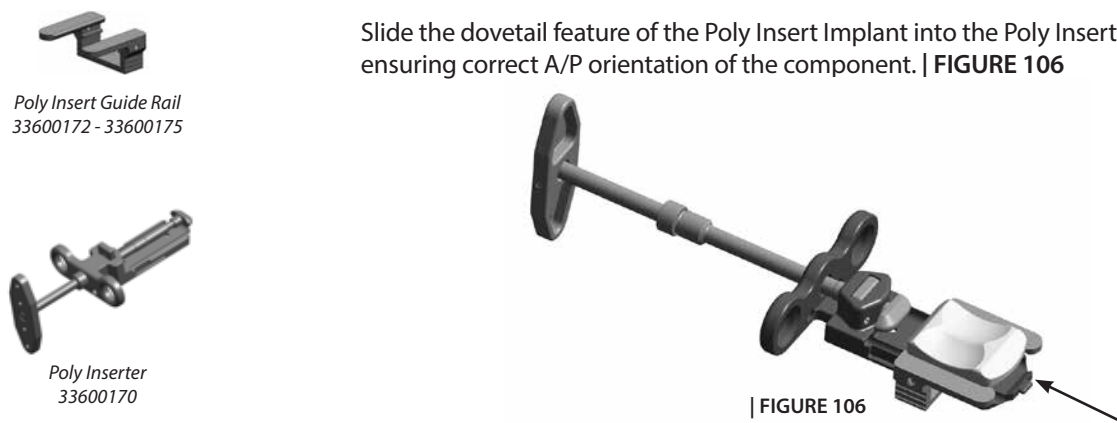

Slide the Poly Inserter Assembly over the Attachment Screws and flush to the surface of the Tibial Tray. Thread an Attachment Nut (33600191) over the end of each Attachment Screw to tightly secure the Poly Inserter in place. | **FIGURE 107**



| **FIGURE 107**

CAUTION: Properly irrigate prior to poly insertion. It is important to remove any fragments of bone or soft tissue from the lock detail on the tibial tray to ensure that the polyethylene will seat completely within the tibial tray lock detail.



Attachment Nut
33600191

To begin Poly insertion, unlock the plunger and push it forward until it comes into contact with the Poly Inserter housing. | FIGURES 108 and 109

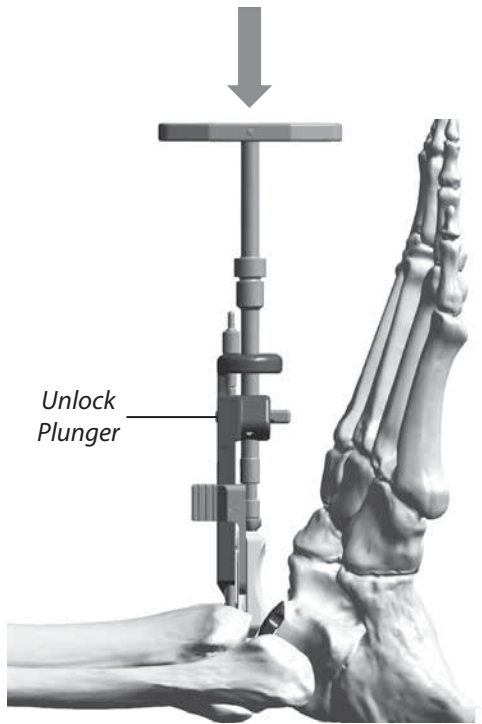

| FIGURE 108

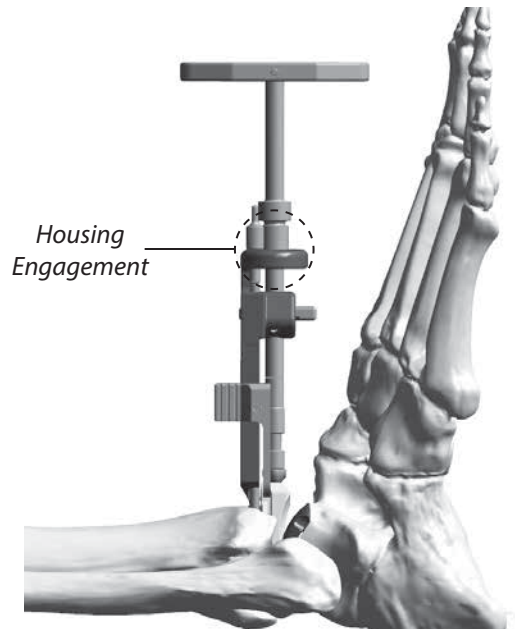

| FIGURE 109

Once it contacts the housing, the plunger can be turned (clock-wise) to continue advancing the Poly Insert into the Tibial Tray. | FIGURE 110

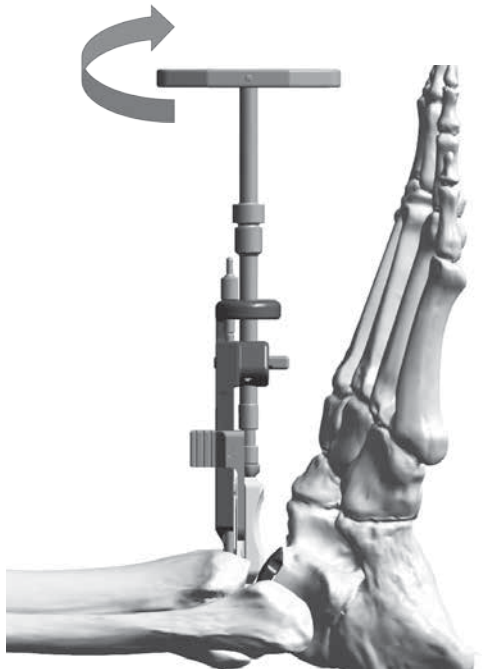

| FIGURE 110

After the plunger has reached maximum depth, unthread the two Attachment Nuts, remove the Poly Inserter housing, and unthread the two Attachment Screws from the tibial tray. | **FIGURE 111**



| **FIGURE 111**

In some cases, the poly may not fully seat using the insertion tool. In these rare cases only, line up the tip of the Straight Tibial Tray Impactor (33600141) with the groove in the anterior face of the poly insert. Angle the Impactor slightly and use a gentle distal to proximal mallet strike to complete the seating.

CAUTION: *Striking the Impactor with excessive force can result in the Tibial Tray pegs plowing through cancellous bone, leaving the tibial tray posteriorly translated from the anterior tibia cortex.*

Check for proper articulation and observe the range of motion under fluoroscopy, ensuring appropriate gliding mechanics for the prosthesis. Also, perform one final check to be sure all components are appropriately seated. | FIGURES 112 and 113
Close the wound and cast foot in slight plantar flexion.



| FIGURE 112



| FIGURE 113

Explant Information

INSERT REPLACEMENT

The Poly Insert has a pre-drilled hole feature on the anterior face. To remove the Poly Insert, first use a pin driver to install the Bone Removal Screw through the pre-drilled hole. Attached the Ratcheting Handle and pull distally on the Removal Screw in an attempt to unlock the Insert from the Tibial Tray. A narrow osteotome may be inserted into the anterior region of the insert to facilitate removal. A hemostat may be used to remove the insert once it is no longer locked to the tibial tray. Care must be taken not to scratch or damage any component that is not intended to be removed.

TIBIA AND TALAR COMPONENTS

To remove the components, small osteotomes, power saws, or other surgical instruments may be used to disrupt the bone-cement interface. Care must be exhibited to save remaining bone stock as well as to prevent fracture. Once the components have been removed, rongeurs or small osteotomes as well as other surgical instruments may be used to remove the remaining cement.

If the removal of the implant is required due to revision or failure of the device, the surgeon should contact the manufacturer using the contact information located on the back cover of this surgical technique to receive instructions for returning the explanted device to the manufacturer for investigation.

Postoperative Management

Postoperative care is the responsibility of the medical professional.

INBONE® Talar Dome Technique

If the surgeon chooses to use an INBONE® Talar Dome instead of an INFINITY® Talar Dome this is possible due to the identical articulation geometry of the two systems. Follow these steps after the Coronal Sizing Guide is properly positioned (page 21).

Bone Resection

Ensure that all Adjustment Block positions are locked out with the Hex Driver and place four 2.4mm Steinmann Pins (200072) into the Coronal Sizing Guide. | **FIGURE 114** Place the two tibial pins first then place the talar pins.

CAUTION: During installation of the distal talar pins it is critical that the ankle be positioned at 90°

Using the Tibial Corner Drill (33600048), bi-cortically drill both proximal corners of the tibia. | **FIGURE 115**

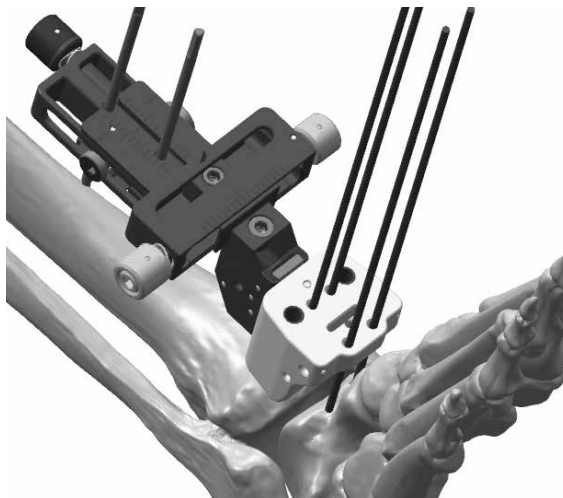

| **FIGURE 114**

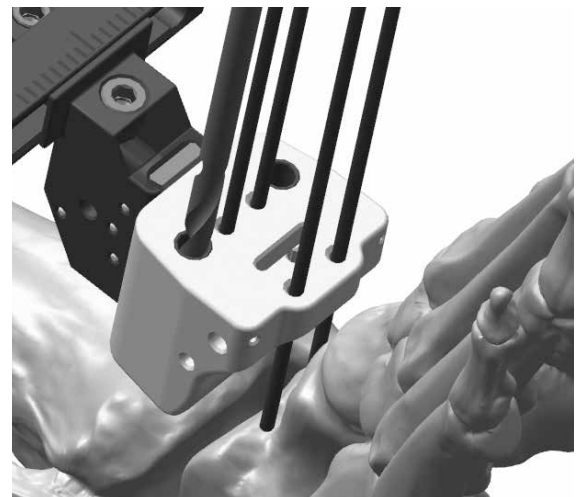

| **FIGURE 115**

Remove the Coronal Sizing Guide and slide the appropriately sized INFINITY®/INBONE® Resection Guide (33620252 through 33620255) over the four 2.4mm Pins and secure into the Adjustment Block using the Hex Driver. | **FIGURE 116** Next, install two 2.4mm Pins through the INBONE® talar hole locations (proximal to the slot) and into the talus. | **FIGURE 117**

Alternately, the two pin holes distal to the slot can be used if they are accessible and provide better bone purchase.



| **FIGURE 116**



| **FIGURE 117**

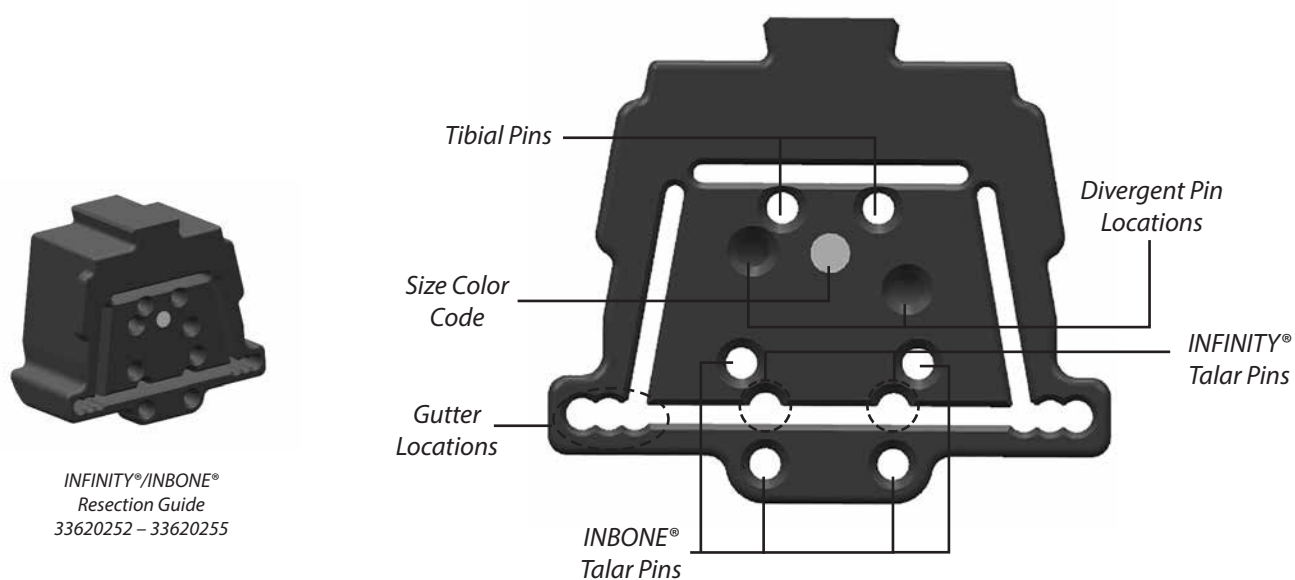

Remove the two 2.4mm Pins from the talar resection slot. Using the Pin Cutter trim the Pins flush to the surface of the Resection Guide. | **FIGURE 118**

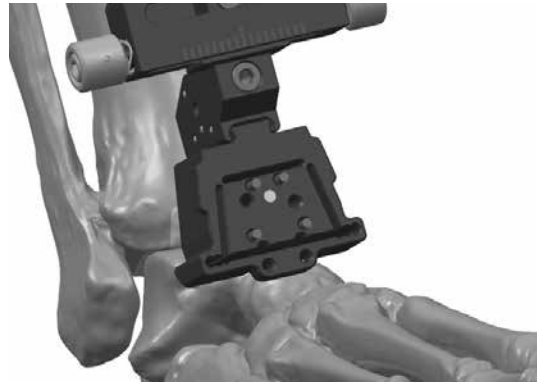

| **FIGURE 118**

Optionally the surgeon can install a 2.4mm Steinmann Pin into each gutter location and an additional 2.4mm Pin through one of the divergent pin locations. | **FIGURE 119** When using a divergent pin always use the medial option (in which the pin travels medial to lateral). This will help avoid the neurovascular bundle just behind the medial malleolus.

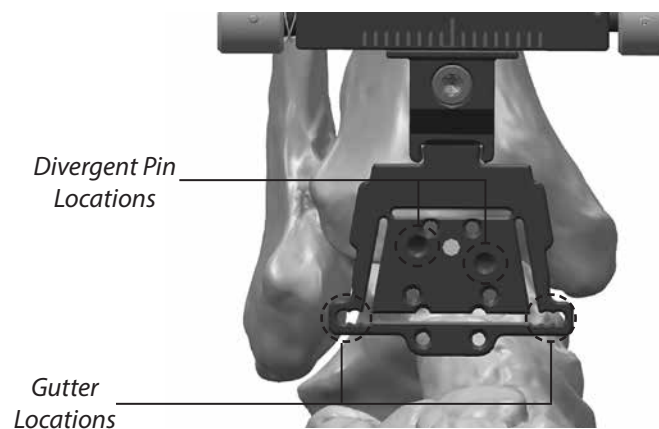

| **FIGURE 119**

Using the Pin Cutter trim the gutter pins flush to the surface of the Resection Guide. Leave enough length on the divergent pin to allow its later removal with a pin driver or pin puller but short enough to allow saw blade clearance in the medial resection slot (approximately 15mm).

Bone Removal & Tibial Preparation

Refer to pages 29 - 34 for instructions on bone removal and tibia preparation for the INFINITY® Tibial Tray.

Implanting Tibial Tray

Refer to pages 43 - 45 for instructions on the implantation of the INFINITY® Tibial Tray.

Verify Talar Dome Size

Perform a thorough gutter debridement. The surgeon must be certain that there is no residual bone impinging between the talus and the medial fibula and lateral tibia. The talus must now be completely independent of the remaining ankle joint, free to rotate into its anatomic center of rotation, as well as translate to establish a position beneath the tibial tray. To achieve this, a generous debridement may be necessary.

Using the Poly Trial Holding Tool (IB200110) install the appropriately sized Poly Insert Trial (33621106 through 33625512) into the Tibial Tray. | **FIGURE 120** The locking tab of the Poly Insert Trial should engage the Tibial Tray.

Assemble the appropriately sized Talar Dome Trial (IB220902 through IB220905) and Talar Dome Holding Tool (IB200010) and introduce the Dome Trial into the joint space. | **FIGURE 121**

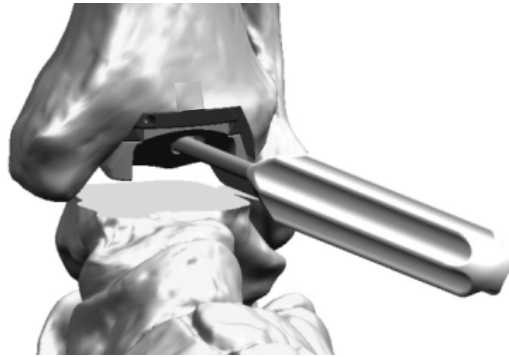

| **FIGURE 120**

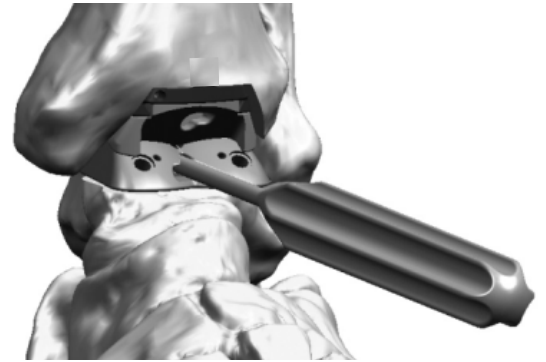

| **FIGURE 121**



The surgeon has two options for Talar Dome implant size at this juncture: either the matching size for the implanted Tibial Tray, or one size smaller. It is beneficial to assess both sizes under A/P and lateral fluoroscopic images. Please note that the A/P image is critical for sizing the talar component, as the surgeon's goal is to minimize overhang of the talar component, and thus minimize prosthetic impingement in the medial and lateral gutters of the ankle joint. | **FIGURES 122 and 123**

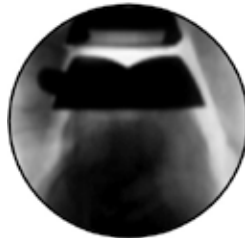

| **FIGURE 122**

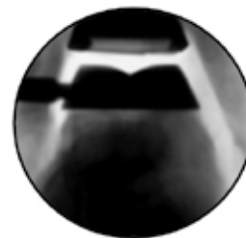

| **FIGURE 123**

Trial Reduction

Under lateral plane fluoroscopy, ensure the posterior portion of the talar component is resting on the posterior portion of the patient's residual talus (establish congruence). | **FIGURE 124**

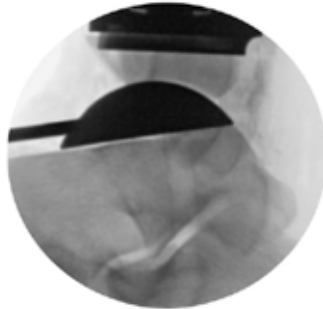

| **FIGURE 124**

While holding the talus in this position, use a marking pen to mark the anterior portion of the talar component with reference to the patient's residual talus.

Be sure to observe the talar component with reference to the line on the residual talus previously drawn. This will ensure the talar component does not migrate anteriorly during the range of motion.

To accurately perform the range of motion, place some axial compression of the components to maintain position, and flex and extend the ankle. The surgeon will observe the talar component rotating into the anatomic position for this particular patient. Note that the surgeon must not only be cognizant of the talar position in the lateral plane, but must simultaneously maintain medial/lateral coverage as evidenced by the previous A/P plane fluoroscopic views.

Once the Talar Dome Trial has settled into optimum anatomical position, install two 1.4mm pins (500036) through the Talar Dome Trial to temporarily hold it in place.

| **FIGURE 125**

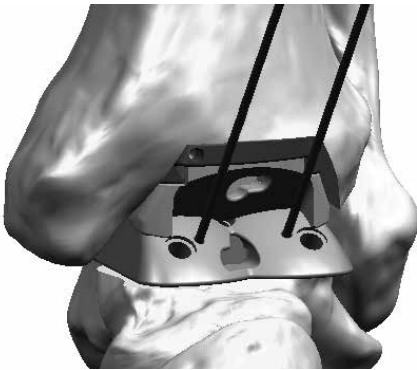

| **FIGURE 125**

NOTE: with the talar component pinned in position, the surgeon should once again place the ankle through a range of motion to ensure tibio-talar articular congruence. Also, confirm through lateral fluoroscopy that the prosthesis did not shift anteriorly.

Refer back to page 41 for further details on choosing the appropriate polyethylene thickness.

Talar Preparation

Using the 4mm Anterior Peg Drill (IB200020), drill a hole through the medial and lateral openings in the Talar Dome Trial. The drill has a hard stop designed to set the appropriate drilling depth in the talus for the Talar Dome anterior pegs. | **FIGURE 126**

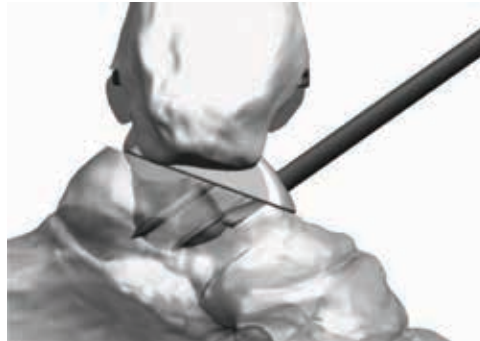

| **FIGURE 126**

Use the Poly Insert Trial Holding Tool to remove the Poly Insert Trial. The foot may be plantarflexed to aid in removal of Poly Insert Trial. | **FIGURES 127 and 128**

CAUTION: *The Poly Insert Trial has a small locking tab that engages the Tibial Tray. To remove Poly Insert Trial, be sure to first pull down on the holding tool to disengage tab before pulling out.*

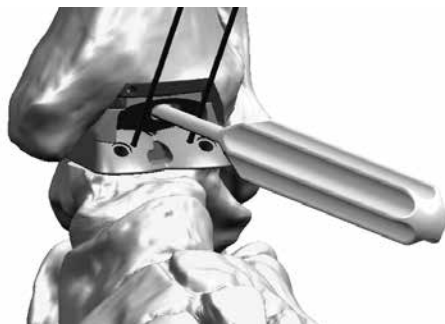

| **FIGURE 127**



| **FIGURE 128**

Install a 2.4mm Steinmann Pin through the center of the Talar Dome Trial to the depth of the selected Talar Stem using a lateral view to verify depth. Be certain that the Talar Dome Trial is sitting flush with the cut line of the talus before placing this pin. | **FIGURE 129**



| **FIGURE 129**



Remove 1.4mm Pins and use the Talar Dome Trial Holding Tool to slide the Talar Dome Trial off the remaining 2.4mm Pin. The foot may be plantarflexed to aid in removal of the Talar Dome Trial.

Ream for Talar Stem

Install the appropriate length Talar Stem Reamer (10mm-200432010 or 14mm-200432014) over the pin and ream to the depth of the selected talar stem. | **FIGURE 130** The reamer has a hard stop designed to set the appropriate reaming depth. | **FIGURE 131** Optionally, use a lateral fluoroscopic view to verify depth.



| FIGURE 130

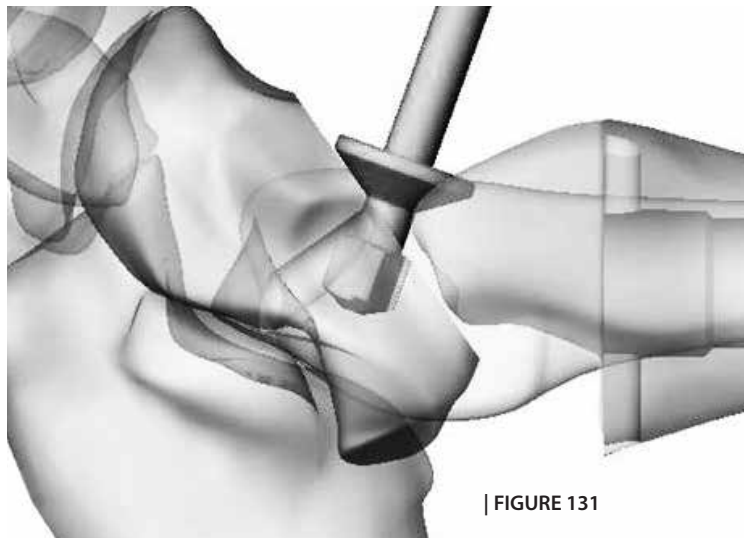

| FIGURE 131



Talar Stem Reamers
(10mm-200432010)
(14mm-200432014)

CAUTION: The Talar Stem is not intended for subtalar fusion or subtalar joint impingement. Please carefully evaluate the anatomy of each patient before implantation.

Remove the Reamer and Steinmann Pin.

Assemble Talar Stem

Insert the appropriate sized Talar Stem into the bottom of the Talar Dome | **FIGURE 132**, aligning the oblong post and matching the oblong hole in the Talar Stem. Talar Stem and anterior pegs should be parallel.

Insert the Talar Stem and Talar Dome assembly into the Strike Block (IB200060). | **FIGURE 133**

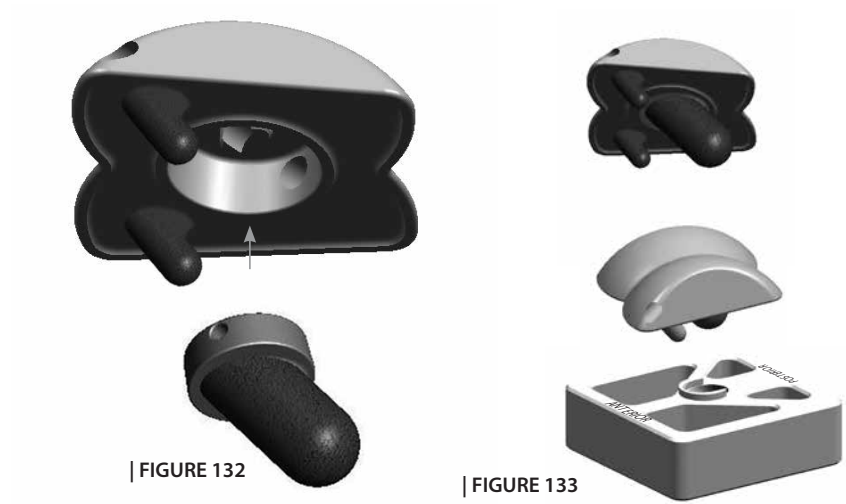

Align the Dome Strike Tool (IB200030 and IB200031) on the Talar Dome and with a mallet, hit the top of the strike tool 2-3 times to fully seat the Talar Stem. | **FIGURE 134**

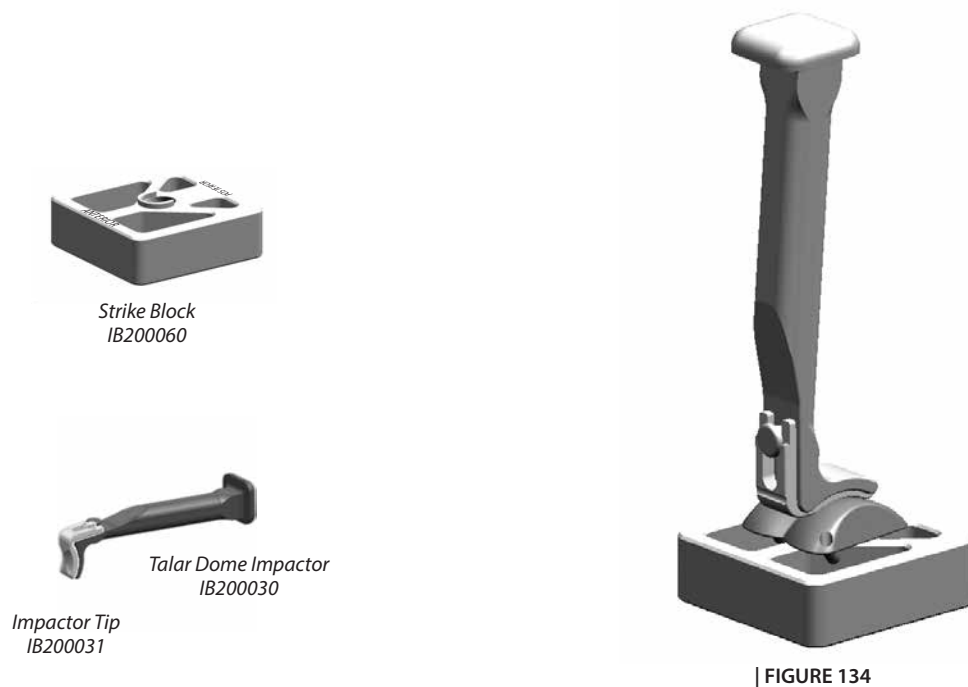

Install Talar Dome

Place the foot in plantar flexion and insert the Tibial Tray Protector (33620152 through 33620155) into the Tibial Tray to protect the Talar Dome surface during installation. Apply bone cement to the bottom surface of the Talar Dome.

Thread the M4 Holding Tool (200364003) into the corner of the Talar Dome and introduce the Talar Dome into the joint space, aligning the Talar Stem and pegs with the prepared holes in the talus. | **FIGURE 135** Once the Talar Dome is aligned, remove the Tray Protector.

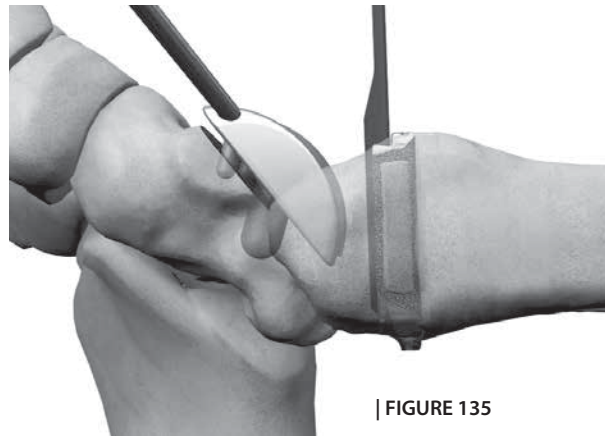

| FIGURE 135

CAUTION: The INBONE® Total Ankle is intended for cemented use only.

Align the Talar Dome Impactor on the Talar Dome and with a mallet, hit the top of the Impactor to fully seat the Talar Dome. | **FIGURE 136** Utilize a lateral fluoroscopic image to ensure that the Talar Dome is fully seated. If the Talar Dome is difficult to fully seat in hard bone, it may be advisable to remove the Talar Dome and increase the diameter of the anterior peg holes slightly with the 4mm drill.

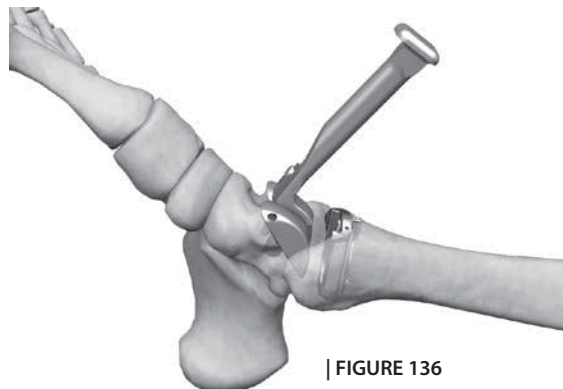

| FIGURE 136



Tibial Tray Protector
33620152 - 33620155



M4 Holding Tool
200364003

Install Poly Insert

Following final impaction of the Talar Dome, refer to pages 47-51 for instructions on Poly Insert Installation.

Talar Re-Cut Option

After the talar resection is made, the surgeon still has an option to make an additional 2mm talar re-cut. Thread the Insertion Handle (33600130) into the Talar Recut Guide (33609056) and introduce the Guide into the joint space. Make sure the paddle of the Guide is seated flat on the resected talus and install two 2.4mm Steinmann Pins through the Guide into the talus. | **FIGURE 137**

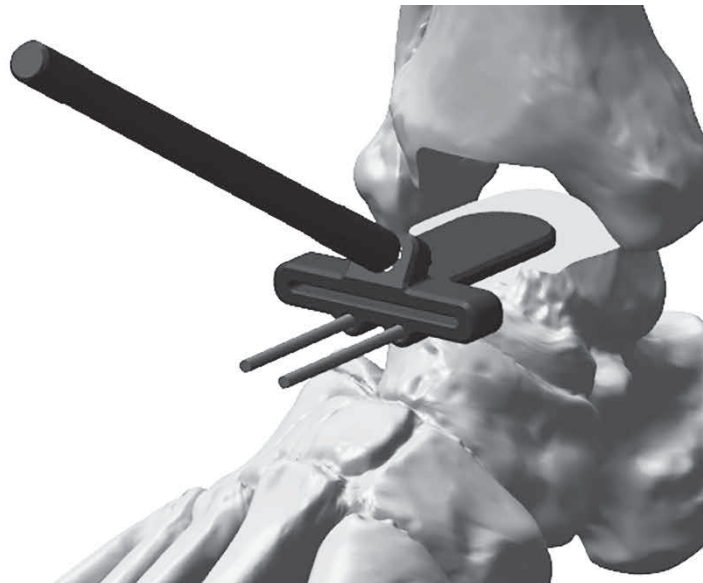

| **FIGURE 137**

Make an additional 2mm talar bone resection through the slot of the Resection Guide. | **FIGURE 138**

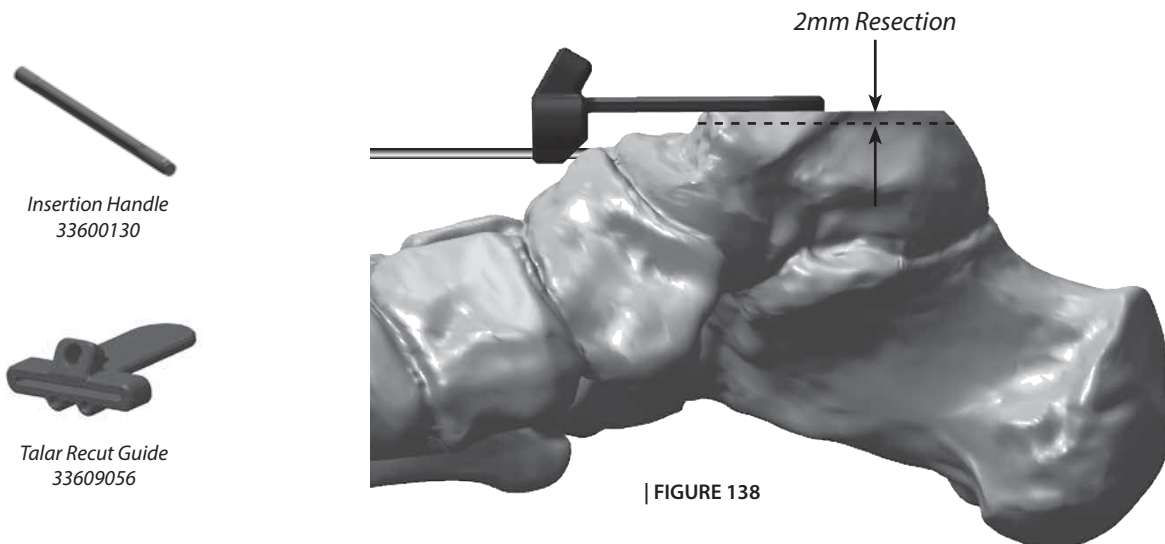

| **FIGURE 138**

INFINITY® Instrumentation

3365KIT1 Case 1, Tray 1

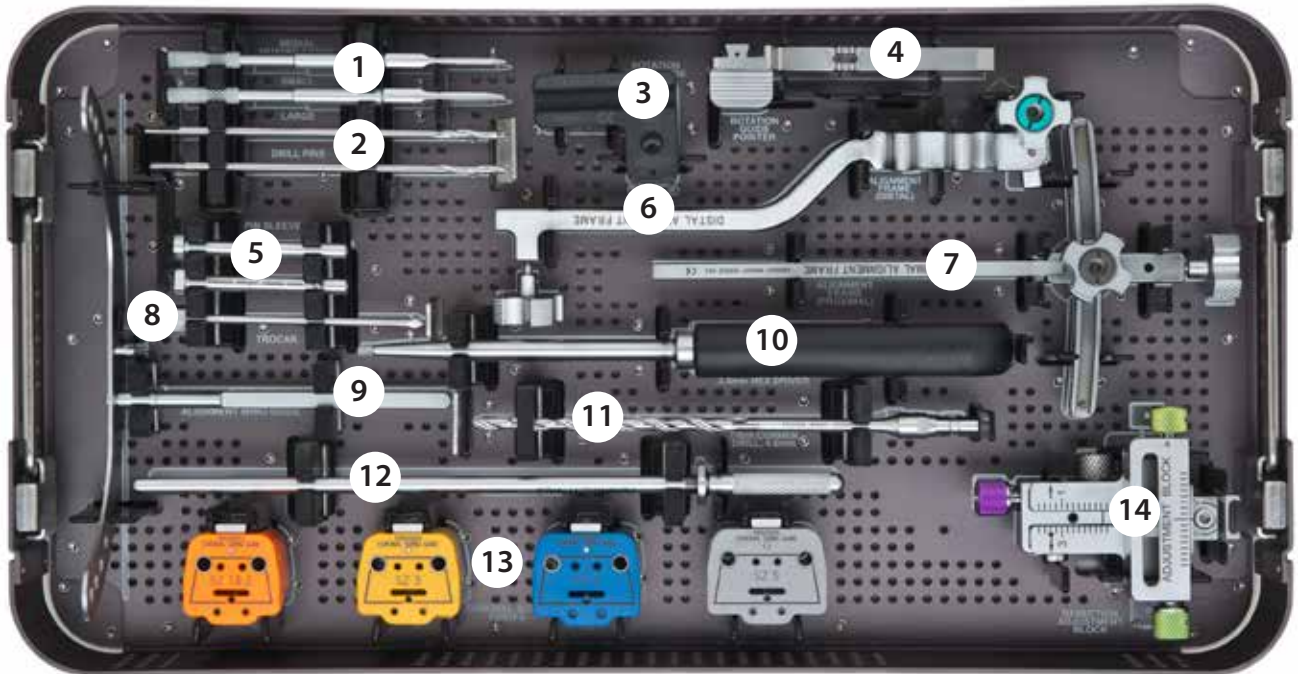

- | | |
|---|---|
| 1. Medial Gutter Forks (33600009 & 33600010) | 8. Trocar (33600026) |
| 2. Pins 3.2mm x 102mm (33610001) | 9. Alignment Wing Guide (33600023) |
| 3. Rotation Guide Slide (33600012) | 10. 3.5mm Hex Driver (E5001005) |
| 4. Rotation Guide Pointer (33600011) | 11. 4.8mm Tibial Corner Drill (33600048) |
| 5. Pin Sleeves (33600025) | 12. Alignment Rod (33600024) |
| 6. Alignment Frame Distal Assembly (33600020) | 13. Coronal Sizing Guides (33620032 - 33620035) |
| 7. Alignment Frame Proximal Assembly (33600021) | 14. Resection Guide Adjustment Block (33600030) |

3365KIT1
Case 1, Tray 2

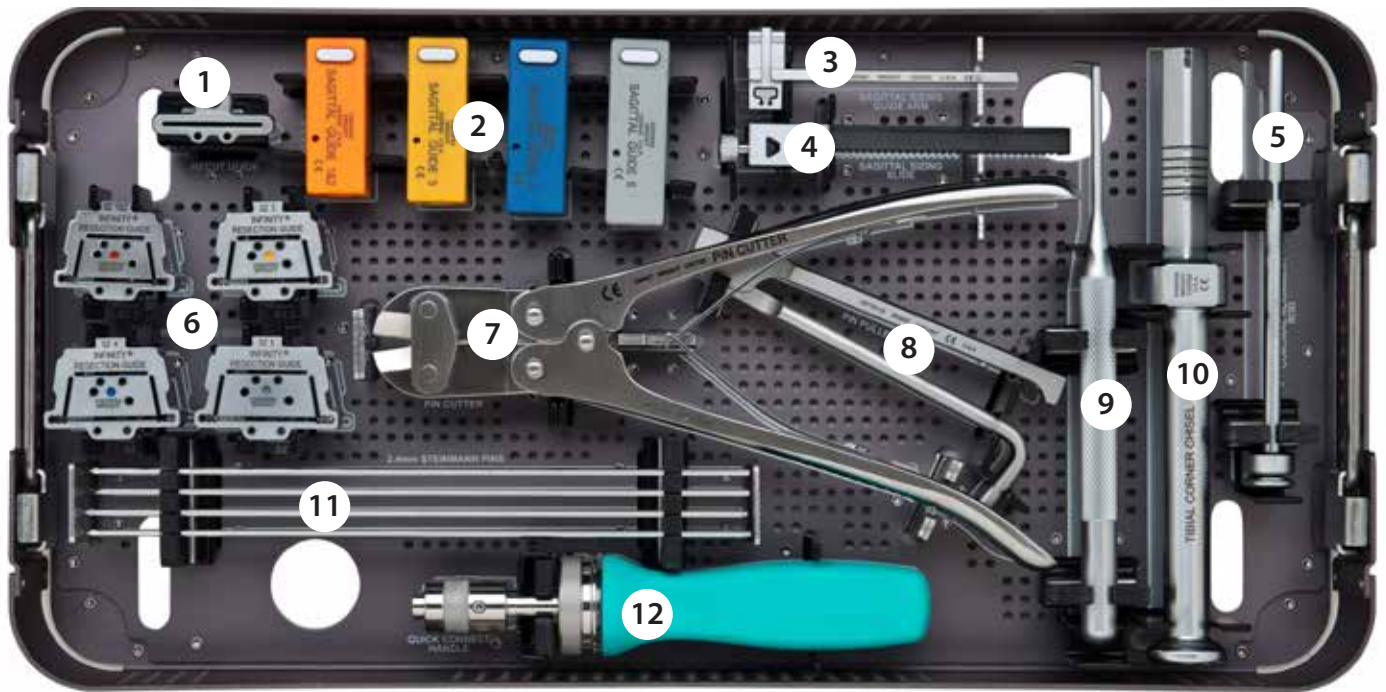

1. Talar 2mm Recut Guide (33609056)
2. Sagittal Sizing Guides (33620042 - 33620045)
3. Sagittal Sizing Guide Arm (33600040)
4. Sagittal Sizing Guide Ratchet Arm (33600068)
5. Coronal Alignment Rod (33600027)
6. Resection Guides (33620052 - 33620055)
7. Pin Cutter (200427)
8. Pin Puller (18770140)
9. Bone Release Tool (IB200050)
10. Tibia Corner Chisel (33600058)
11. Steinmann Pins 2.4mm (200072)
12. Quick Connect Handle (44180025)

3365KIT1
Case 2, Tray 1

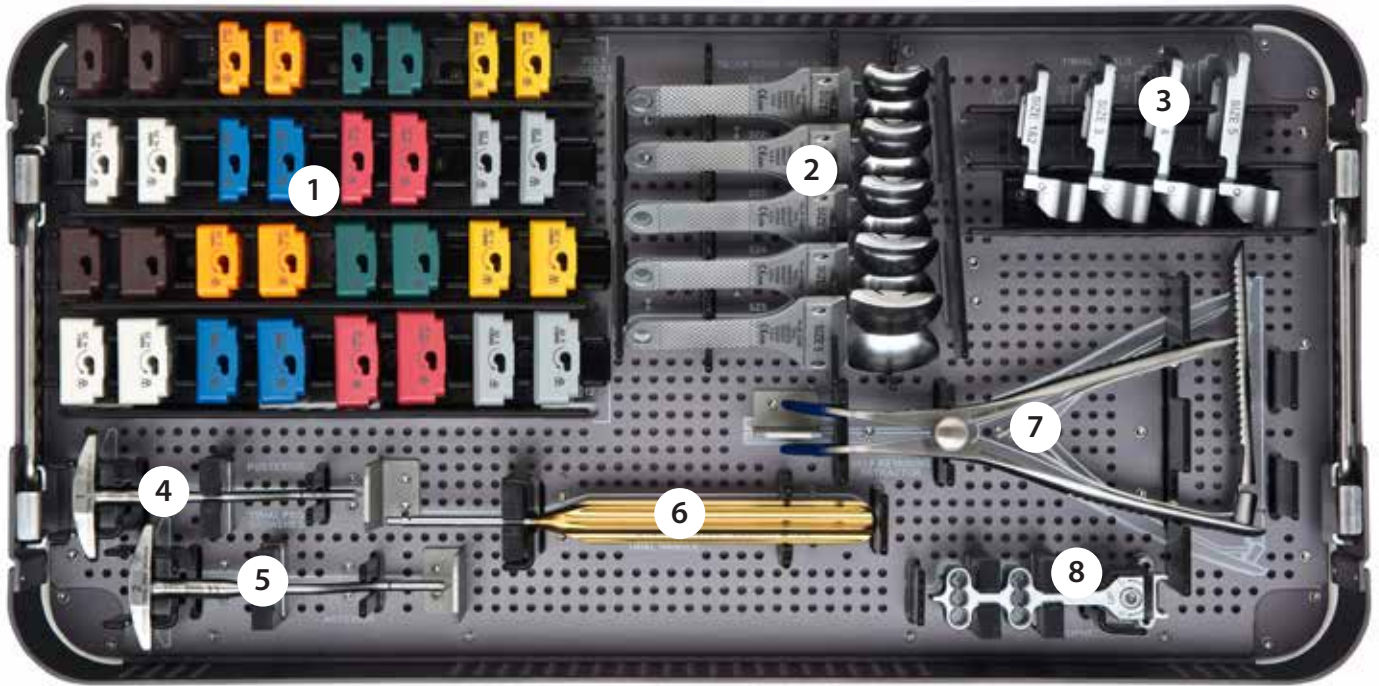

1. Poly Insert Trials (33621106 - 33625512)
2. Talar Dome Trials (33600071 - 33600075)
3. Tibial Tray Trials (33620062 - 33620065)
4. Posterior Tibial Peg Broach (33600069)
5. Anterior Tibial Peg Broach (33600067)
6. Poly Trial Handle (IB200110)
7. Self Retaining Retractor (33609012)
8. PROPHECY® Conversion Guide (33600200)

3365KIT1
Case 2, Tray 2

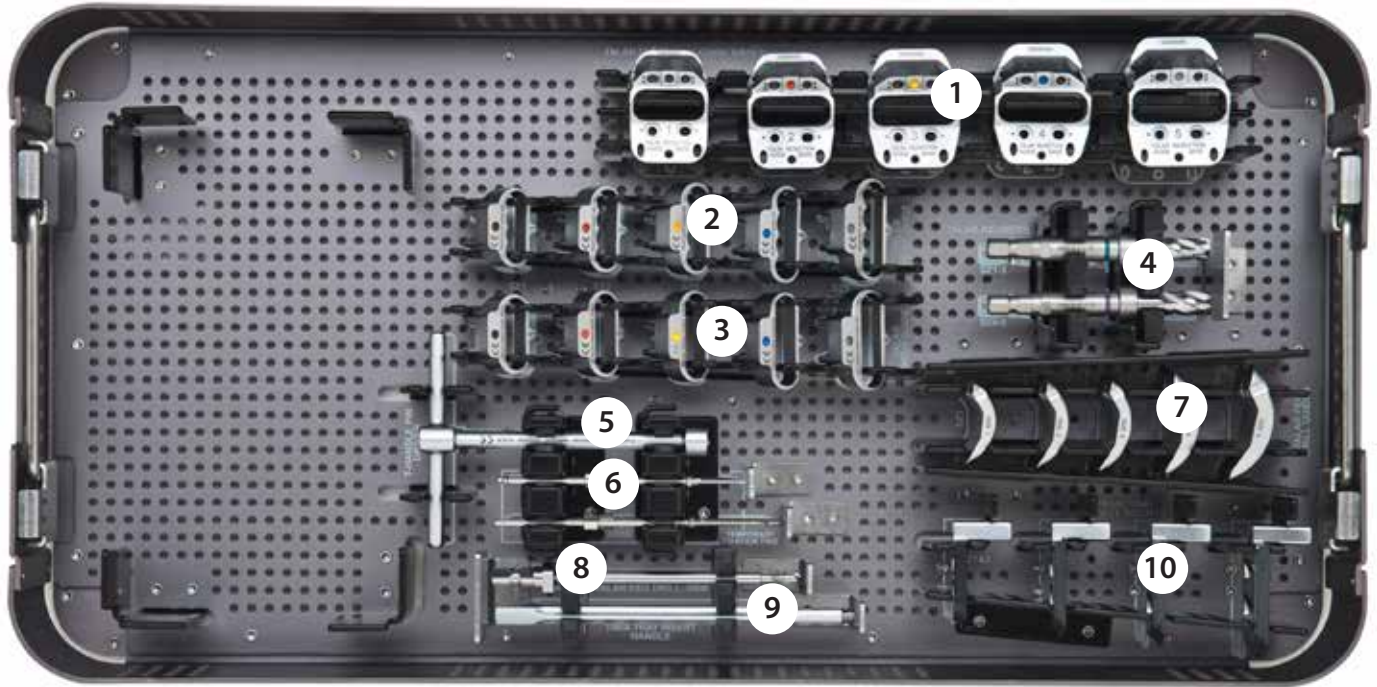

1. Talar Resection Guide Bases (33600091 - 33600095)
2. Talar Chamfer Pilot Guides (33600101 - 33600105)
3. Talar Chamfer Finish Guides (33600111 - 33600115)
4. Talar Reamers (33600123 & 33600126)
5. T-Handle Pin Driver (33600120)
6. Threaded Talar Pins (33610002 & 33610003)
7. Talar Peg Drill Guides (33600161 - 33600165)
8. Talar Peg Drill, 4mm (IB200020)
9. Tibial Tray Insertion Handle (33600130)
10. Tibial Tray Impaction Inserts (33620132 - 33620135)

Case 2, Caddy 1



1. Tibial Spacer Guides (33600424 - 33600456)
2. Talar Resection Guide (33600400)
3. Caddy (33600470)

3365KIT1
Case 3, Tray 1

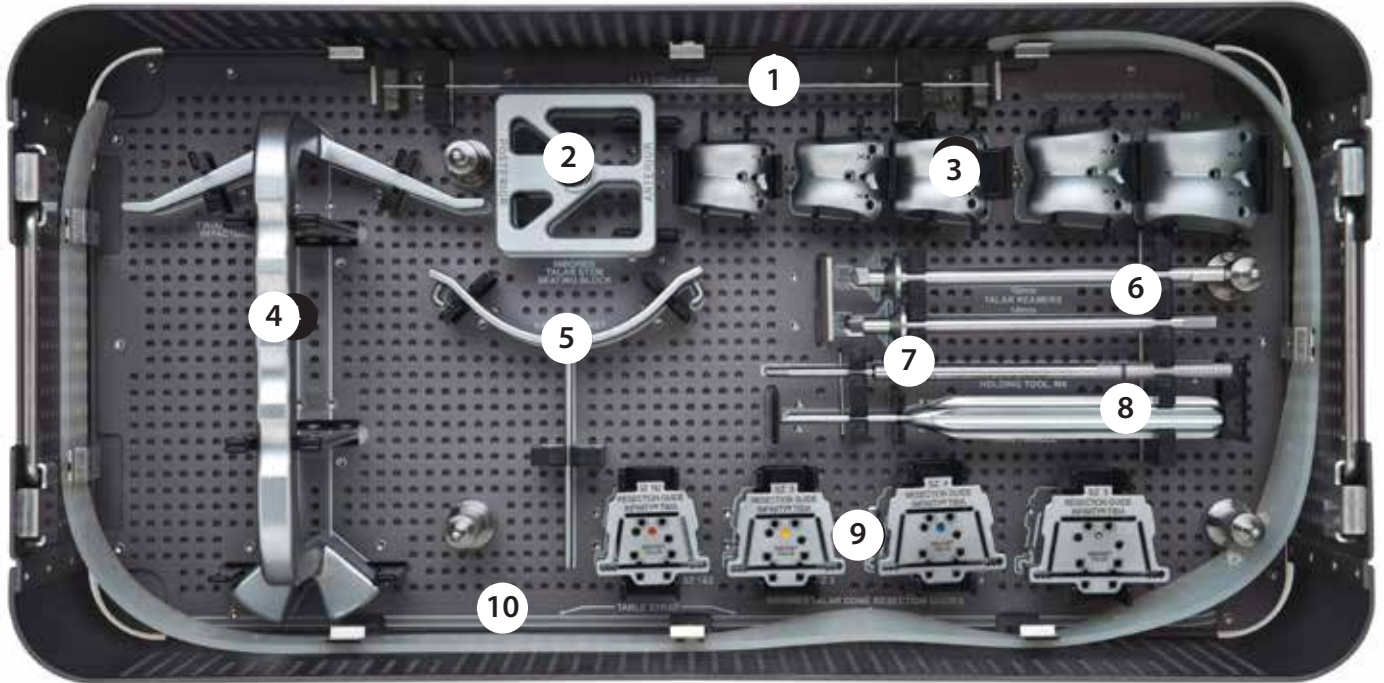

1. K-Wires 1.4mm x 228mm (500036)
2. INBONE® Talar Stem Seating Block (IB200060)
3. INBONE® Talar Dome Trials (IB220901 – IB220905)
4. Tibial Tray Offset Impactor (33600140)
5. Knee Bracket (33600022)
6. INBONE® Talar Stem Reamers (200432010 & 200432014)
7. INBONE® Talar Dome M4 Holding Tool (200364003)
8. INBONE® Talar Dome Trial Handle (IB200010)
9. INBONE® Talar Dome Resection Guides (33620252 - 33620255)
10. Table Strap (200430)

3365KIT1
Case 3, Tray 2

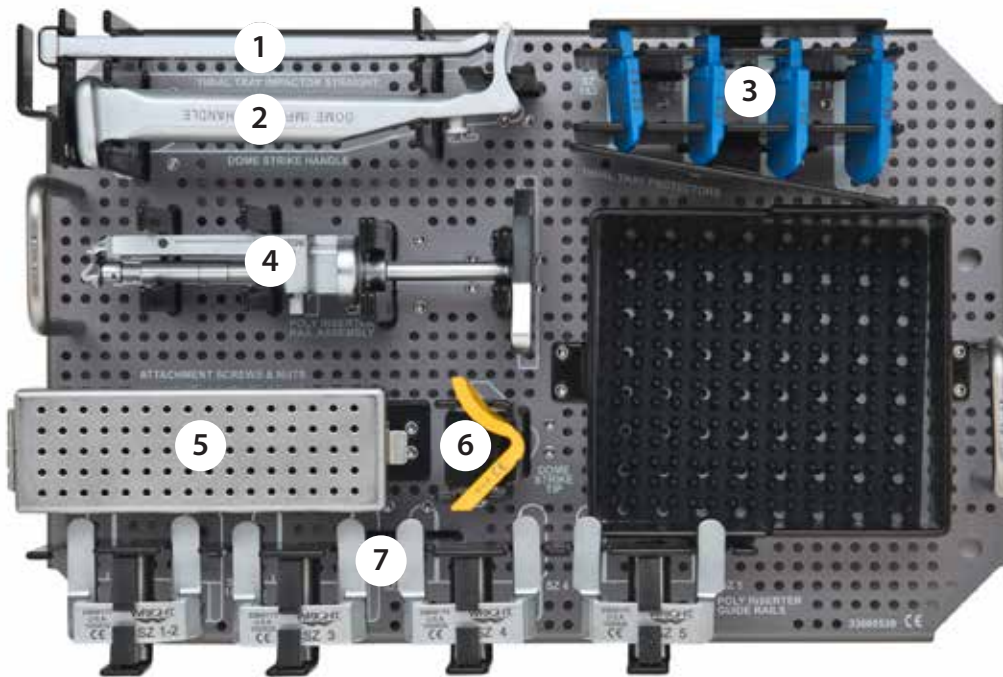

1. Straight Impactor (33600141)
2. Dome Strike Handle (IB200030)
3. Tibial Tray Protectors (33620152 - 33620155)
4. Poly Inserter Assembly (33600170)
5. Attachment Screws (33600190) & Nuts (33600191)
6. Dome Strike Tip (IB200031)
7. Poly Inserter Guide Rails (33600172 - 33600175)

3365KIT1 - INFINITY® Instrument Kit

Part #	Description
33600009	MEDIAL GUTTER FORK, SMALL
33600010	MEDIAL GUTTER FORK, LARGE
33600011	ROTATION GUIDE POINTER
33600012	ROTATION GUIDE SLIDE
33600020	ALIGNMENT FRAME DIST SUB ASSY
33600021	ALIGNMENT FRAME PROX SUB ASSY
33600022	KNEE BRACKET
33600023	ALIGNMENT WING GUIDE
33600024	ALIGNMENT ROD
33600025	PIN SLEEVE
33600026	TROCAR
33600030	RESECTION ADJUSTMENT BLOCK
33620032	CORONAL SIZING GUIDE, SZ 1-2
33620033	CORONAL SIZING GUIDE, SZ 3
33620034	CORONAL SIZING GUIDE, SZ 4
33620035	CORONAL SIZING GUIDE, SZ 5
33620040	SAGITTAL SIZING GUIDE ARM
33620042	SAGITTAL SIZING GUIDE, SZ1-2
33620043	SAGITTAL SIZING GUIDE, SZ3
33620044	SAGITTAL SIZING GUIDE, SZ4
33620045	SAGITTAL SIZING GUIDE, SZ5
33600048	TIBIAL CORNER DRILL, 4.8MM
33620052	RESECTION GUIDE, SZ 1-2
33620053	RESECTION GUIDE, SZ 3
33620054	RESECTION GUIDE, SZ 4
33620055	RESECTION GUIDE, SZ 5
33600058	TIBIAL CORNER CHISEL

Part #	Description
33620062	TRIAL TIBIAL TRAY, SZ1-2
33620063	TRIAL TIBIAL TRAY, SZ3
33620064	TRIAL TIBIAL TRAY, SZ4
33620065	TRIAL TIBIAL TRAY, SZ5
33600069	TIBIAL PEG DRILL, 3.7MM
33600071	TRIAL TALAR DOME, SZ1
33600072	TRIAL TALAR DOME, SZ2
33600073	TRIAL TALAR DOME, SZ3
33600074	TRIAL TALAR DOME, SZ4
33600075	TRIAL TALAR DOME, SZ5
33600091	TALAR RESECT GUIDE BASE, SZ1
33600092	TALAR RESECT GUIDE BASE, SZ2
33600093	TALAR RESECT GUIDE BASE, SZ3
33600094	TALAR RESECT GUIDE BASE, SZ4
33600095	TALAR RESECT GUIDE BASE, SZ5
33600101	ANTER TALAR PILOT GUIDE, SZ1
33600102	ANTER TALAR PILOT GUIDE, SZ2
33600103	ANTER TALAR PILOT GUIDE, SZ3
33600104	ANTER TALAR PILOT GUIDE, SZ4
33600105	ANTER TALAR PILOT GUIDE, SZ5
33600111	ANTER TALAR FINISH GUIDE, SZ1
33600112	ANTER TALAR FINISH GUIDE, SZ2
33600113	ANTER TALAR FINISH GUIDE, SZ3
33600114	ANTER TALAR FINISH GUIDE, SZ4
33600115	ANTER TALAR FINISH GUIDE, SZ5
33600120	T-HANDLE PIN DRIVER
33600123	TALAR REAMER, SZ 1-3
33600126	TALAR REAMER, SZ 4-6

3365KIT1 - INFINITY® Instrument Kit

Part #	Description
33600130	TIBIAL TRAY INSERT HANDLE
33620132	TIB TRAY IMPACT INSERT, SZ1-2
33620133	TIB TRAY IMPACT INSERT, SZ3
33620134	TIB TRAY IMPACT INSERT, SZ4
33620135	TIB TRAY IMPACT INSERT, SZ5
33600140	TIBIAL TRAY IMPACTOR, OFFSET
33600141	TIBIAL TRAY IMPACTOR, STRAIGHT
33620152	TIBIAL TRAY PROTECTOR, SZ1-2
33620153	TIBIAL TRAY PROTECTOR, SZ3
33620154	TIBIAL TRAY PROTECTOR, SZ4
33620155	TIBIAL TRAY PROTECTOR, SZ5
33600161	TALAR PEG DRILL GUIDE, SZ1
33600162	TALAR PEG DRILL GUIDE, SZ2
33600163	TALAR PEG DRILL GUIDE, SZ3
33600164	TALAR PEG DRILL GUIDE, SZ4
33600165	TALAR PEG DRILL GUIDE, SZ5
33600170	POLY INSERTER RAIL ASSY
33600172	POLY INSERT GUIDE RAIL, SZ1-2
33600173	POLY INSERT GUIDE RAIL, SZ3
33600174	POLY INSERT GUIDE RAIL, SZ4
33600175	POLY INSERT GUIDE RAIL, SZ5
33600190	POLY INSERT ATTACHMENT SCREW
33600191	POLY INSERT ATTACHMENT NUT
33620252	RESECTION GUIDE INBONE® TALUS, SZ1-2
33620253	RESECTION GUIDE INBONE® TALUS, SZ3
33620254	RESECTION GUIDE INBONE® TALUS, SZ4
33620255	RESECTION GUIDE INBONE® TALUS, SZ5

Part #	Description
33621106	TRIAL POLY INSERT, SZ1/1+ 6MM
33621108	TRIAL POLY INSERT, SZ1/1+ 8MM
33621110	TRIAL POLY INSERT, SZ1/1+ 10MM
33621112	TRIAL POLY INSERT, SZ1/1+ 12MM
33622206	TRIAL POLY INSERT, SZ2 6MM
33622208	TRIAL POLY INSERT, SZ2 8MM
33602210	TRIAL POLY INSERT, SZ2 10MM
33602212	TRIAL POLY INSERT, SZ2 12MM
33623206	TRIAL POLY INSERT, SZ2+ 6MM
33623208	TRIAL POLY INSERT, SZ2+ 8MM
33603210	TRIAL POLY INSERT, SZ2+ 10MM
33603212	TRIAL POLY INSERT, SZ2+ 12MM
33623306	TRIAL POLY INSERT, SZ3 6MM
33623308	TRIAL POLY INSERT, SZ3 8MM
33603310	TRIAL POLY INSERT, SZ3 10MM
33603312	TRIAL POLY INSERT, SZ3 12MM
33624307	TRIAL POLY INSERT, SZ3+ 7MM
33624309	TRIAL POLY INSERT, SZ3+ 9MM
33604311	TRIAL POLY INSERT, SZ3+ 11MM
33604313	TRIAL POLY INSERT, SZ3+ 13MM
33624406	TRIAL POLY INSERT, SZ4 6MM
33624408	TRIAL POLY INSERT, SZ4 8MM
33604410	TRIAL POLY INSERT, SZ4 10MM
33604412	TRIAL POLY INSERT, SZ4 12MM
33625407	TRIAL POLY INSERT, SZ4+ 7MM
33625409	TRIAL POLY INSERT, SZ4+ 9MM
33605411	TRIAL POLY INSERT, SZ4+ 11MM
33605413	TRIAL POLY INSERT, SZ4+ 13MM
33625506	TRIAL POLY INSERT, SZ5 6MM
33625508	TRIAL POLY INSERT, SZ5 8MM
33605510	TRIAL POLY INSERT, SZ5 10MM
33605512	TRIAL POLY INSERT, SZ5 12MM

3365KIT1 - INFINITY® Instrument Kit

Part #	Description
33609012	SELF RETAINING LAMINAR SPREADERS
33610001	PIN 3.2MM X 102MM
33610002	TEMP FIX PIN, TALAR GUIDE LONG
33610003	TEMP FIX PIN, TALAR GUIDE SHORT
E5001005	EVOLUTION® 3.5MM HEX DRIVER
200430	INBONE® TABLE STRAP
200072	INBONE® STEINMANN PIN, 2.4MM
IB200050	INBONE® BONE RELEASE TOOL
IB200110	POLY TRIAL HANDLE
IB200020	INBONE® DRILL TALAR PEG, 4MM
IB200030	INBONE® HANDLE DOME STRIKER
IB200031	INBONE® DOME STRIKE TIP SULCUS
500036	1.4MM K-WIRE
18770140	ORTHOLOC® PIN PULLER
200427	INBONE® PIN CUTTER 3.2
44180025	7.0 MUC HANDLE QUICK CONNECT
IB220901	INBONE® TRIAL TAL DOME #1 SULC
IB220902	INBONE® TRIAL TAL DOME #2 SULC
IB220903	INBONE® TRIAL TAL DOME #3 SULC
IB220904	INBONE® TRIAL TAL DOME #4 SULC
IB220905	INBONE® TRIAL TAL DOME #5 SULC
200432010	INBONE® TALAR REAMER, 10 MM
200432014	INBONE® TALAR REAMER, 14 MM
IB200060	INBONE® SEAT BLOCK TALAR STEM
IB200010	INBONE® TALAR DOME TRIAL HANDLE
200364003	INBONE® HOLDING, TOOL, M4
33600200	PROPHECY® CONVERSION INSTRUMENT

Part #	Description
33600400	TALAR RESECTION GUIDE
33600424	TIBIAL SPACER GUIDE, SZ1&2 MINUS
33600426	TIBIAL SPACER GUIDE, SZ1&2 STD
33600434	TIBIAL SPACER GUIDE, SZ3 MINUS
33600436	TIBIAL SPACER GUIDE, SZ3 STD
33600444	TIBIAL SPACER GUIDE, SZ4 MINUS
33600446	TIBIAL SPACER GUIDE, SZ4 STD
33600454	TIBIAL SPACER GUIDE, SZ5 MINUS
33600456	TIBIAL SPACER GUIDE, SZ5 STD
33600470	CADDY, TIBIAL SPACER GUIDE

Implant Specifications

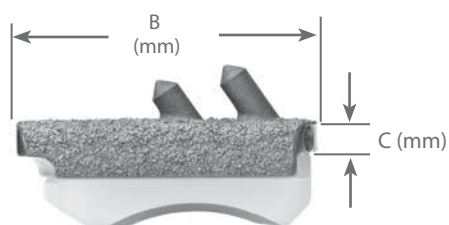
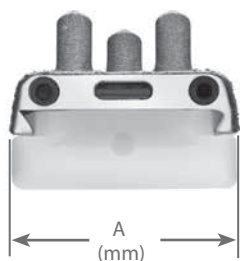

INFINITY® Tibial Component

SIZE	A	B	C
1	26	34	5
2	26	38	5
3	28	38	5
3 Long	28	41	5
4	31	41	5
4 Long	31	44	5
5	34	44	5
5 Long	34	48	5

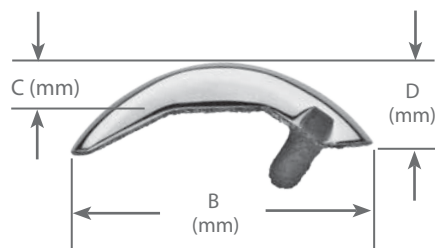
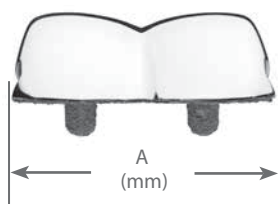

INFINITY® Talar Component

SIZE	A	B	C	D
1	30	31	5	10
2	32	34	5	10
3	34	36	5	10
4	36	39	6	11
5	38	42	7	12

Ordering Information



INFINITY® Tibial Component

Part #	Description
33650001	TIBIAL TRAY SZ1 STD
33650002	TIBIAL TRAY SZ2 STD
33650003	TIBIAL TRAY SZ3 STD
33650004	TIBIAL TRAY SZ4 STD
33650005	TIBIAL TRAY SZ5 STD
33650013	TIBIAL TRAY SZ3 LONG
33650014	TIBIAL TRAY SZ4 LONG
33650015	TIBIAL TRAY SZ5 LONG



INFINITY® Talar Component

Part #	Description
33630021	TALAR DOME SZ 1
33630022	TALAR DOME SZ 2
33630023	TALAR DOME SZ 3
33630024	TALAR DOME SZ 4
33630025	TALAR DOME SZ 5



INBONE® II Talar Component

Part #	Description
220220901	TALAR DOME SZ 1 SULCUS
220220902	TALAR DOME SZ 2 SULCUS
220220903	TALAR DOME SZ 3 SULCUS
220220904	TALAR DOME SZ 4 SULCUS
220220905	TALAR DOME SZ 5 SULCUS



INBONE® II Talar Stem

Part #	Description
200347901	TALAR STEM 10MM
200347902	TALAR STEM 14MM

INFINITY® Poly Insert



Part #	Description
33651106	POLY INSERT, SZ1/1+ 6MM
33651108	POLY INSERT, SZ1/1+ 8MM
33651110	POLY INSERT, SZ1/1+ 10MM
33651112	POLY INSERT, SZ1/1+ 12MM
33652206	POLY INSERT, SZ2 6MM
33652208	POLY INSERT, SZ2 8MM
33652210	POLY INSERT, SZ2 10MM
33652212	POLY INSERT, SZ2 12MM
33653206	POLY INSERT, SZ2+ 6MM
33653208	POLY INSERT, SZ2+ 8MM
33653210	POLY INSERT, SZ2+ 10MM
33653212	POLY INSERT, SZ2+ 12MM
33653306	POLY INSERT, SZ3 6MM
33653308	POLY INSERT, SZ3 8MM
33653310	POLY INSERT, SZ3 10MM
33653312	POLY INSERT, SZ3 12MM
33654307	POLY INSERT, SZ3+ 7MM
33654309	POLY INSERT, SZ3+ 9MM
33654311	POLY INSERT, SZ3+ 11MM
33654313	POLY INSERT, SZ3+ 13MM
33654406	POLY INSERT, SZ4 6MM
33654408	POLY INSERT, SZ4 8MM
33654410	POLY INSERT, SZ4 10MM
33654412	POLY INSERT, SZ4 12MM
33655407	POLY INSERT, SZ4+ 7MM
33655409	POLY INSERT, SZ4+ 9MM
33655411	POLY INSERT, SZ4+ 11MM
33655413	POLY INSERT, SZ4+ 13MM
33655506	POLY INSERT, SZ5 6MM
33655508	POLY INSERT, SZ5 8MM
33655510	POLY INSERT, SZ5 10MM
33655512	POLY INSERT, SZ5 12MM



Wright Medical Technology, Inc.

1023 Cherry Road
Memphis, TN 38117
800 238 7117
901 867 9971
www.wmt.com

Wright Medical EMEA

Atlas Arena, Australia Building
Hoogoorddreef 7
1101 BA Amsterdam
the Netherlands
011 31 20 565 9060

Wright Medical UK Ltd.

Unit 1, Campus Five
Letchworth Garden City
Hertfordshire SG6 2JF
United Kingdom
011 44 (0)845 833 4435

™Trademarks and *Registered marks of
Wright Medical Technology, Inc.
©2014 Wright Medical Technology, Inc.
All Rights Reserved.